



Operating Instructions
colorCONTROL MFA

MFA-7
MFA-14
MFA-21
MFA-28

Sensor system for testing LED function, color and intensity

MICRO-EPSILON Eltrotec GmbH
Manfred-Wörner-Straße 101

73037 Göppingen / Germany

Tel. +49 (0) 7161 / 98872-300
Fax +49 (0) 7161 / 98872-303
e-mail eltrotec@micro-epsilon.com
www.micro-epsilon.com

Contents

1.	Safety	5
1.1	Symbols Used	5
1.2	Warnings	5
1.3	Notes on CE Marking	5
1.4	Intended Use	6
1.5	Proper Environment.....	6
2.	Functional Principle, Technical Data	7
2.1	Short Description	7
2.2	Measuring Principle	7
2.3	Functions	7
2.4	Display Element	7
2.5	Technical Data	8
	2.5.1 Technical Data for Controller	8
	2.5.2 Technical Data for MFS Sensors	9
3.	Delivery	10
3.1	Unpacking/Included in Delivery	10
3.2	Storage	10
4.	Installation and Assembly	11
4.1	Installation and Mounting	11
4.2	Mounting the MFS Receiver Sensor.....	12
4.3	Status LED	12
4.4	Electrical Connections Controller.....	13
	4.4.1 Connection Options	13
	4.4.2 Pin Assignment.....	13
	4.4.3 Supply Voltage	14
	4.4.4 Data Transmission for RS422, RS232 or USB	14
	4.4.5 RS422 (with IF2001/USB Converter).....	15
5.	Operation	16
5.1	Initial Operation	16
5.2	Operation using sensorTOOL	16
	5.2.1 Controller Search	16
5.3	System Parameterization via sensorTOOL (Settings Menu).....	17
	5.3.1 Modulation Setup	17
	5.3.2 Configuration.....	18
	5.3.2.1 Configuration/Measurement	18
	5.3.2.2 Global Settings.....	19
	5.3.2.3 Channel Overview	20
5.4	Measurement Menu.....	21
	5.4.1 Data Acquisition.....	21
	5.4.2 Signal Processing.....	22
	5.4.3 Data Acquisition Table.....	23
	5.4.4 Recording and Saving Measurement Data	23
5.5	Single Value Menu	24
5.6	Color Display Menu	25
5.7	Info Menu	26
	5.7.1 Reset to Factory Settings	26
	5.7.2 Export / Import Settings	26
	5.7.3 Disconnecting.....	27
6.	Serial Interface (RS422, RS232 and USB)	27
7.	Cleaning	28
8.	Software Support with MEDAQLib	28
9.	Disclaimer	28
10.	Service, Repair	29
11.	Decommissioning, Disposal	29

Appendix

A 1	Optional Accessories	30
A 2	Factory Settings	32
A 3	Software Update	32
A 4	ASCII Communication with Sensor	33
A 4.1	Commands Overview	34
A 4.2	System	35
A 4.2.1	HELP	35
A 4.2.2	GETINFO, Sensor Information	35
A 4.2.3	STATUS.....	36
A 4.2.4	PRINT, Sensor Settings	36
A 4.2.5	PRINT ALL	36
A 4.2.6	GETCHANNELCNT	37
A 4.2.7	BASICSETTINGS	37
A 4.2.8	MEASSETTINGS	37
A 4.2.9	RESET, Rebooting Sensor.....	37
A 4.2.10	RESETCNT, Resetting Counter	37
A 4.2.11	SETDEFAULT	37
A 4.3	Communication	37
A 4.3.1	BAUDRATE	37
A 4.3.2	OUTPUT.....	37
A 4.3.3	DATARATE	37
A 4.3.4	OUT.....	37
A 4.3.5	GETOUTINFO	38
A 4.4	Adjustment / Reference	38
A 4.4.1	DARKCORR	38
A 4.4.2	DARKCORR_OFFSET.....	38
A 4.4.3	WHITECORR	38
A 4.4.4	WHITECORR_FACTOR	38
A 4.5	Measurement.....	38
A 4.5.1	AUTOGAIN.....	38
A 4.5.2	GAIN	38
A 4.5.3	INTEGRATIONTIME.....	39
A 4.5.4	AVERAGING	39
A 4.5.5	COLORSPACE	39
A 4.5.6	GETMEASURE	39
A 4.6	ASCII Error Codes	40
A 5	Measurement Data Format	41

1. Safety

System operation assumes knowledge of the operating instructions.

1.1 Symbols Used

The following symbols are used in these operating instructions:



Indicates a hazardous situation which, if not avoided, may result in minor or moderate injury.

NOTICE

Indicates a situation that may result in property damage if not avoided.



Indicates a user action.

i

Indicates a tip for users.

Measurement

Indicates hardware or a software button/menu.

1.2 Warnings



Connect the power supply according to the safety regulations for electrical equipment.

- > Risk of injury
- > Damage to or destruction of the controller

NOTICE

Avoid shocks and impacts to the sensor and controller.

- > Damage to or destruction of the sensor and/or the controller

The supply voltage must not exceed the specified limits.

- > Damage to or destruction of the controller

Never fold the sensor (optical fiber) and do not bend it in tight radii.

- > Damage to or destruction of the sensor, failure of measuring device

Do not operate the controller if optical components are steamed up or dirty.

- > Failure of the measuring device

1.3 Notes on CE Marking

The following apply to the colorCONTROL MFA-XX series:

- EU Directive 2014/30/EU
- EU Directive 2011/65/EU

Products which carry the CE mark satisfy the requirements of the EU directives cited and the relevant applicable harmonized European standards (EN). The measuring system is designed for use in industrial and laboratory applications. The EU Declaration of Conformity is available to the responsible authorities according to EU Directive, Article 10.

1.4 Intended Use

- The colorCONTROL MFA-7/14/21/28 is designed for use in industrial and laboratory applications. It is used for
 - relative color measurement and testing
 - testing intensities, color and function
 - testing lighting such as LEDs and light bulbs
 - multi-channel testing with up to 28 MFS sensors (MFA-28) at the same time.
- The system must only be operated within the limits specified in the technical data, [see 2.5.1](#).
- The testing system must be used in such a way that no persons are endangered or machines and other material goods are damaged in the event of malfunction or total failure of the system.
- Take additional precautions for safety and damage prevention in case of safety-related applications.

1.5 Proper Environment

- Protection class: IP20

Unused optical inputs can be closed for their protection with MFS blind plugs, as function could be impaired or lost if they become dirty.

- Temperature range:
 - Operation: 0 ... +50 °C
 - Storage: -10 ... +55 °C
- Humidity: 20 ... 80 % RH (non-condensing)
- Ambient pressure: Atmospheric pressure

2. Functional Principle, Technical Data

2.1 Short Description

The colorCONTROL MFA-XX is an optical controller for precise color recognition for industrial measurement tasks, built into a sturdy aluminum housing. The controller is characterized by parallel measurement of multiple measuring channels (up to 28 in an MFA-28), high color accuracy, data output via interfaces, and intuitive operation. Up to 28 MFS sensors with optical fibers can be connected to a colorCONTROL MFA-28 controller. These sensors can be adapted to different measuring tasks, for example LED testing (binning), primary light source testing, and display testing.

2.2 Measuring Principle

The measuring system for relative color measurement/testing consists of an evaluation unit – the MFA-XX controller – and a MFS sensor. The sensor is connected to the controller via an optical fiber with an integrated plastic fiber. The specimen (lighting/LED) emits electromagnetic radiation with the range of 400-700 nm (light). The light emitted from the test subject is received via an MFS sensor at a working distance of approx. 5 mm. The light is transmitted via the optical fiber of the MFS sensor to a perceptive true-color sensor (XYZ) of the MFA controller.

The three wavelength frequency ranges, i.e.

- X = long wave,
- Y = medium wave and
- Z = short wave frequency ranges

from the specimen are used to determine the light emitted thereby and transformed into a selected color space. These color values are calculated according to the procedure described in DIN 5033. The transformed values (color) can be queried by the controller or continuously transmitted via the interface.

2.3 Functions

- Detecting electromagnetic radiation of between 400 ... 700 nm and converting it into color values
- Outputting the measurement data via RS232, RS422 or USB

2.4 Display Element

The status LED of the controller indicates the following:

- Green: error-free operation
- Orange: error
- Blue: overflow

2.5 Technical Data

2.5.1 Technical Data for Controller

Model		MFA-7	MFA-14	MFA-21	MFA-28
Article number		11094994	11094995	11094996	11094997
No. of measurement channels		7	14	21	28
Repeatability ¹		xy < ±0.000025			
Spectral range		400 ... 700 nm			
Sensitivity range		1 ... 50,000 lx			
Measurement values		XYZ, xyY, Luv, uvL, RGB, CCT, λ _{dom}			
Measuring rate ²		< 100 Hz	< 59 Hz	< 40 Hz	< 30 Hz
Supply voltage		+ 24 V DC ± 10%			
Max. current consumption		500 mA			
Digital interface		USB, RS422 or RS232			
Connection	Optical	7 connections or sockets for MFS sensors	14 connections or sockets for MFS sensors	21 connections or sockets for MFS sensors	28 connections or sockets for MFS sensors
	Electrical	8-pin female connector M12 for RS422/RS232/USB 4-pin male connector for power supply			
Mounting		4x M4 fastening screws			
Temperature range	Storage	-10 ... +55 °C			
	Operation	+0 ... +50 °C			
Humidity		20 ... 80 % RH (non-condensing)			
Shock (DIN EN 60068-2-27)		15 g / 6 ms + two directions, 1000 shocks in each of 3 axes			
Vibration (DIN EN 60068-2-6)		2 g / 10 ... 500 Hz + 10 cycles in each of 3 axes			
Protection class (DIN EN 60529)		IP20			
Material		Aluminum housing, coated in black			
Weight		247 g	262 g	278 g	293 g
Compatibility		With all MFS sensors			
Control and displays elements		Status LED (green: error-free operation; orange: error; blue: overflow)			

1) Details valid for 5 mm LEDs

2) Valid for a baud rate of 115200 and the transmission of color values plus timestamp. The measuring rate decreases when transmitting λ_{dom} and CCT.

2.5.2 Technical Data for MFS Sensors

Model	MFS-22	MFS-K04	MFS-K04-3	MFS-K04-6	MFS-K05/90
Article number	10825504	10825506	10825508	10825510	10825512
Sensor type	Receiver sensor				
Working distance ¹	Start	3 mm	3 mm	3 mm	3 mm
	Optimal	5 mm	5 mm	5 mm	5 mm
	End	11 mm	15 mm	15 mm	15 mm
Measurement spot diameter ¹	Start	4 mm	3 mm	4.5 mm	2x5 mm
	Optimal	6 mm	3 mm	5 mm	2.5x6 mm
	End	16 mm	6 mm	7 mm	4x14 mm
Measurement geometry	0°				90°
Min. target size	Ø 4 mm		Ø 3 mm	Ø 4.5 mm	Ø 5 mm
Sensitivity	Distance ²	xy < 0.003 /mm	xy < 0.002 /mm	xy < 0.003 /mm	xy < 0.004 /mm
	Tilt ²	xy < 0.01 / °	xy < 0.01 / °	xy < 0.02 / °	xy < 0.02 / °
Connection	Integrated plastic fiber cable axial with PVC (P) sheathing, standard length 0.5 m; other lengths 0.3 m... 2.0 m optionally available, min. bending radius 50 mm				
Mounting	MFS plug				
Temperature range	Sensor head	-10 ... +80 °C			
	Cables	-20 ... +80 °C			
Humidity	20 ... 80 % RH (non-condensing)				
Protection class (DIN EN 60529)	IP64	IP44			
Material	PVC, plastic fiber POF-2.2 with PVC sheathing (P)	Aluminum, plastic fiber POF-2.2 with PVC sheathing (P)			
Weight	3.4 g	5.4 g	5.6 g	7.2 g	6.7 g
Compatibility	MFA controller (7, 14, 21, 28)				
Special features	All variants are available in other lengths > 300 mm as well. Lengths of up to 5 m are possible with glass optical fibers. These can also be manufactured for vacuum or high-temperature conditions.				
No. of measurement channels	1				

Details apply in conjunction with a colorCONTROL MFA-7 series controller

1) Measured with a white reference light source 6500 K, 32 lm, 95 Ra

2) Measured with red 637 nm 5 mm LED (1 mA, 11 V DC)

3. Delivery

3.1 Unpacking/Included in Delivery

1x colorCONTROL MFA-7/14/21/28 controller

1 Assembly Instructions

- ▶ Carefully remove the components of the measuring system from the packaging and ensure that the goods are forwarded in such a way that no damage can occur.
- ▶ Check the delivery for completeness and shipping damage immediately after unpacking.
- ▶ If there is damage or parts are missing, immediately contact the manufacturer or supplier.

Optional accessories are listed in the appendix, [see A 1](#).

3.2 Storage

- Temperature range for storage: -10 ... +55 °C
- Humidity: 20 ... 80 % RH (non-condensing)

4. Installation and Assembly

4.1 Installation and Mounting

- Ensure careful handling during installation and operation.

NOTICE

Make sure that the sensors can move freely and that no sharp curves or corners are formed when installing the colorCONTROL MFA-7/14/21/28.

- > Damage to or destruction or failure of the sensor
- > Distortion of test results

The smallest bending radius of the sensor (optical fiber) is 50 mm (permanent) or 10 mm (short-term).

- Make sure that all the light from the LEDs is guided from the sensor to the color chip in the colorCONTROL MFA-XX.

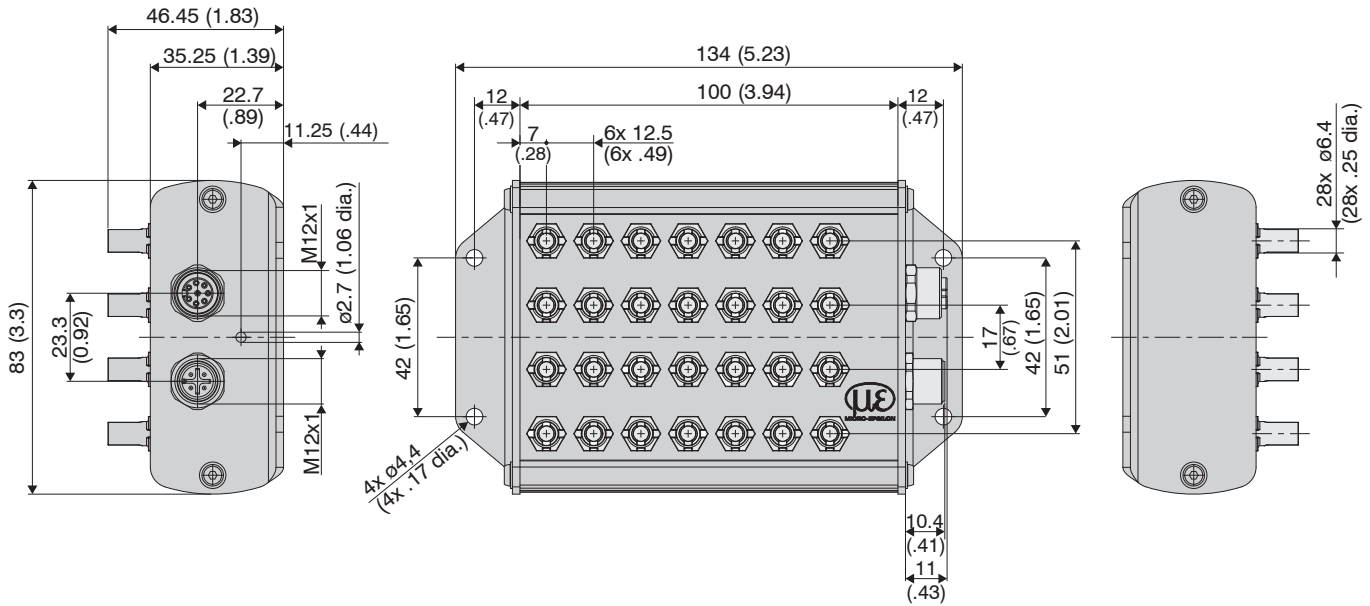

Fig. 1 colorSENSOR MFA-28 dimensional drawing, dimensions in mm

NOTICE

Do not allow the end surfaces of the sensor to strike edges or surfaces. Reduced signal quality or measuring device.

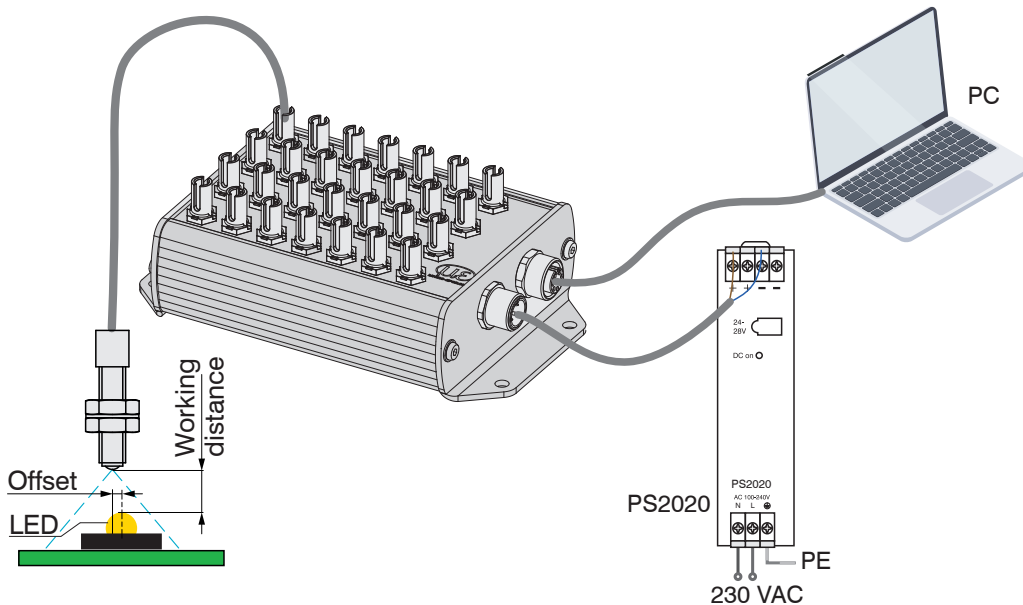

Fig. 2 Typical measurement setup of MFA-XX controller with connected MFS sensor, power supply, and connection to PC

4.2 Mounting the MFS Receiver Sensor

- Minimum bending radius:
 - Short-term 10 mm
 - Permanently 50 mm
- Numerical aperture: 0.47
- Attenuation at 660 nm less than 220 dB/km (typically 190 dB/km)

► Position the sensor over the optical center of the LEDs.

► Maintain a distance of 2 to 15 mm between the LED and the sensor.

• The distance depends on the luminosity of the specimen and the sensor used.

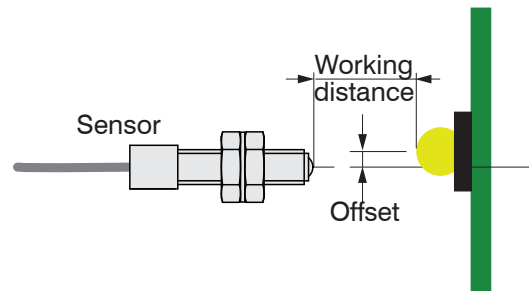
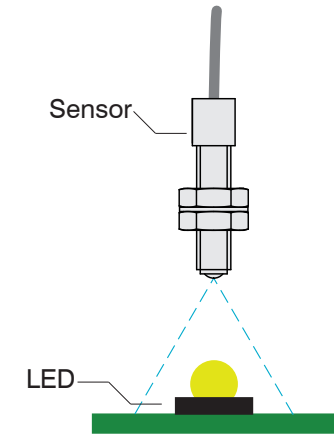

Fig. 3 Positioning the sensor

Fig. 4 Working distance and offset

The intensity of a test depends on the working distance and offset of the LED with respect to the sensor. The permissible offset depends on the measuring spot of the sensor. For more information on the working distance and on the measuring spot, please consult the technical data, [see 2.5.2](#). Several MFS receiver sensors are available for detecting the light, [see A 1](#).

4.3 Status LED

Color	Meaning	Position of the LED
Green	Controller ready to use	
Orange	Error (as soon as a channel is not working correctly, the LED lights up orange)	
Blue	Overflow (as soon as overflow has occurred in a channel, the LED lights up blue)	

4.4 Electrical Connections Controller

4.4.1 Connection Options

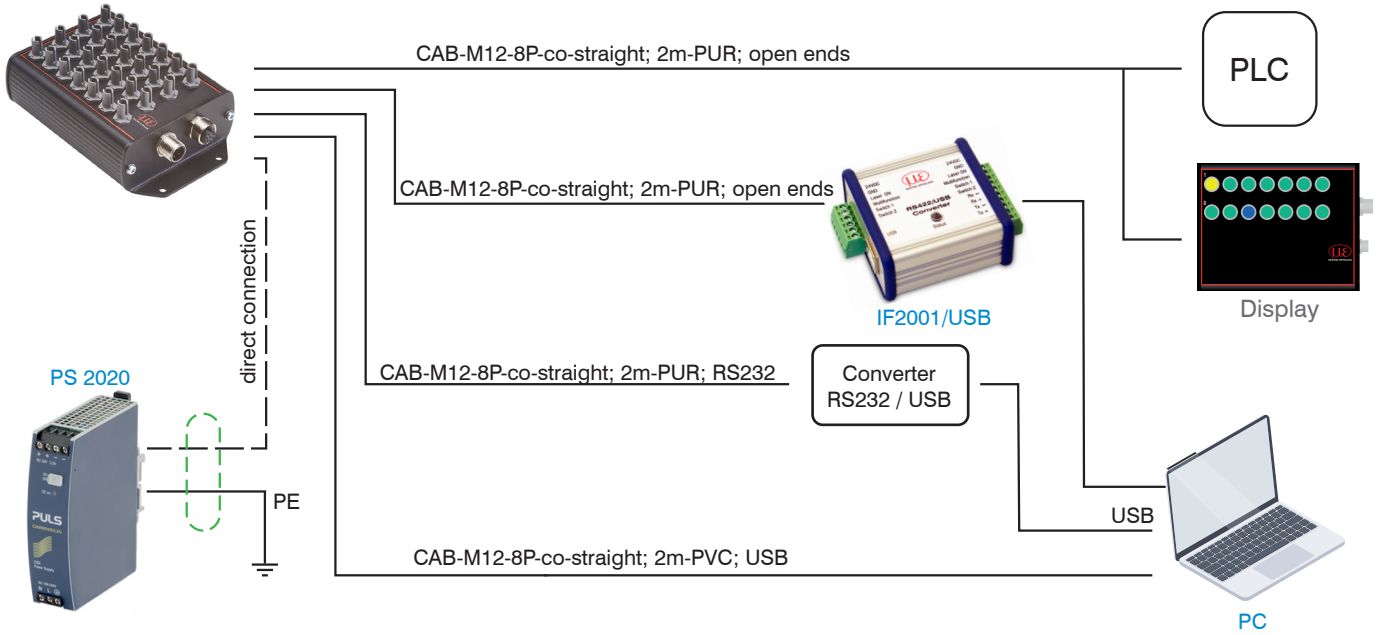

4.4.2 Pin Assignment

The cable shields are connected to the connector housings. The connector housings are in contact with the controller housing.



Perform all electrical connections only in the switched-off state.
> Risk of injury from high voltage.



1	4-pin male connector M12 for power supply
2	8-pin female connector M12 for RS232, RS422 or USB

The frequently used and standardized female connectors M12 allow use of a standard commercial cable to match the specific, special requirements of the specific operating environment. For example, cables are available which are oil-resistant or suitable for use with drag chains.

The power supply and communication connections of the controller are accessible using standardized male and female connectors M12. All connection cables with the features required for the application (e.g. drag chain compatibility or resistance to oil) and the matching coding can be used with the controllers.

4.4.3 Supply Voltage

To connect the supply voltage: CAB-M12-4P-co-fm-straight;

- 4-pin male connector
- 24 VDC \pm 10%, $I_{max} < 500$ mA

Pin	Color ¹	Function	Description
1	Brown	V+	Supply voltage (10 ... 28 VDC)
2	White	-	-
3	Blue	GND	Ground connection
4	Black	-	-
Shield			The cable shield is connected to the housing.



View of controller flange connector

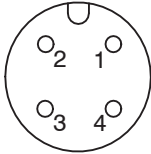

Pin sequence, 4-pin cable socket, viewed from solder side

1) Wire colors CAB-M12-4P-co-fm-straight

➤ Use a shielded cable with a length < 30 m.

MICRO-EPSILON recommends using the optionally available CAB-M12-4P-co-fm-straight cable.

4.4.4 Data Transmission for RS422, RS232 or USB

8-pin female connector for connecting the RS422, RS232 or USB interface. Depending on the interface, there is a separate connection line, with the same data protocol being output via each of the three interfaces, [see 6](#). The interfaces may be operated separately but not simultaneously. The cable shield is connected to the housing.

➤ Connect the cable shield to the evaluation unit.

Use shielded cable with a length of:

- USB cable \leq 3m
- RS232 \leq 10m
- RS422 \leq 15m

MICRO-EPSILON recommends using the optionally available CAB-M12-8P-co-straight cable, [see A 1](#).

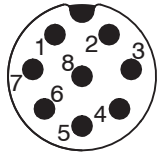
Pin assignment for M12 8-pin female connector (RS422/RS232/USB)			View of controller flange socket	 <p>Pin sequence, 8-pin cable connector, view of solder side</p> <p>2) Wire colors CAB-M12-8P-co-straight</p>	Pin assignment for cable:		
Pin	Wire color on cable ²	Assignment			USB	RS232	RS422
1	White	GND			GND	GND	GND
2	Brown	VUSB			VUSB	-	-
3	Green	D+			D+	-	-
4	Yellow	D-			D-	-	-
5	Gray	RI+			-	GND	RI+
6	Pink	RI-			-	RxD	RI-
7	Blue	DO-			-	TxD	DO-
8	Red	DO+			-		DO+
Shield	The cable shield is connected to the housing.		Shield				

4.4.5 RS422 (with IF2001/USB Converter)

The RS422 interface can be used for configuration as well as for permanent data transmission, even over longer distances. It is interference-resistant and suitable for industrial applications. Distances of up to 1200 m are possible with a twisted-pair cable.

For the connection between sensor and PC, the lines must be crossed.

i Only disconnect or connect the sub-D connection between the RS422 and USB converter when no voltage is flowing.

Characteristics

- Maximum input voltage RX+, RX-: $\pm 14 V_{max}$ internally terminated with 120 Ohm.
- Output voltage TX: $\pm 2 V$, differential at $2 \times 50 \text{ Ohm}$

Parameter

- Baud rate 115200 baud
- Data bits: 8
- Parity: None
- Start/stop bit: 1
- Handshake: No
- Command protocol: ASCII

i The RS422 interface is widely used in industrial applications. Use a suitable USB converter, e.g. the IF2001/USB, [see A 1](#), if your PC/Notebook only has USB ports.

Controller			Terminal, PLC, IF2001/USB Converter from MICRO-EPSILON
Pin	Cable color (Cable: CAB-M12-8P-co-straight)	Function	Function
7	Blue	Tx-	Rx-
8	Red	Tx+	Rx+
6	Pink	Rx-	Tx-
5	Gray	Rx+	Tx+
1	White	GND	GND

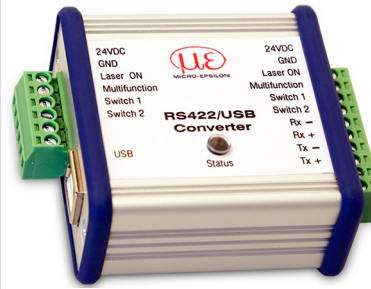

Symmetrical differential signals according to EIA-422, not electrically separated from the voltage supply.

Use a shielded cable with twisted wires, e.g. CAB-M12-8P-co-straight.

Fig. 5 Crossed data lines on receive and transmit side

5. Operation

5.1 Initial Operation

- ▶ Mount the MFA-XX controller as per the mounting instructions, [see 4.1](#).
- ▶ Connect the controller to the downstream display or monitoring units and to the voltage supply.

5.2 Operation using sensorTOOL

sensorTOOL by MICRO-EPSILON is a piece of software that you can use to apply settings to the controller and to view and document measurement data. You can find it online at <https://www.micro-epsilon.com/download/software/sensorTOOL.exe>.

5.2.1 Controller Search

- ▶ Connect the controller to a free USB or RS232 port of your PC and connect the power supply.
- ▶ Start the sensorTOOL program.
- ▶ Select the sensor group `Color` and sensor type `colorSENSOR MFA` from the drop-down menus and click on the  button.

The program will now search for connected MFA-XX sensors on the available interfaces.

- ▶ Select a desired sensor. Click the `Start Data Acquisition` button.

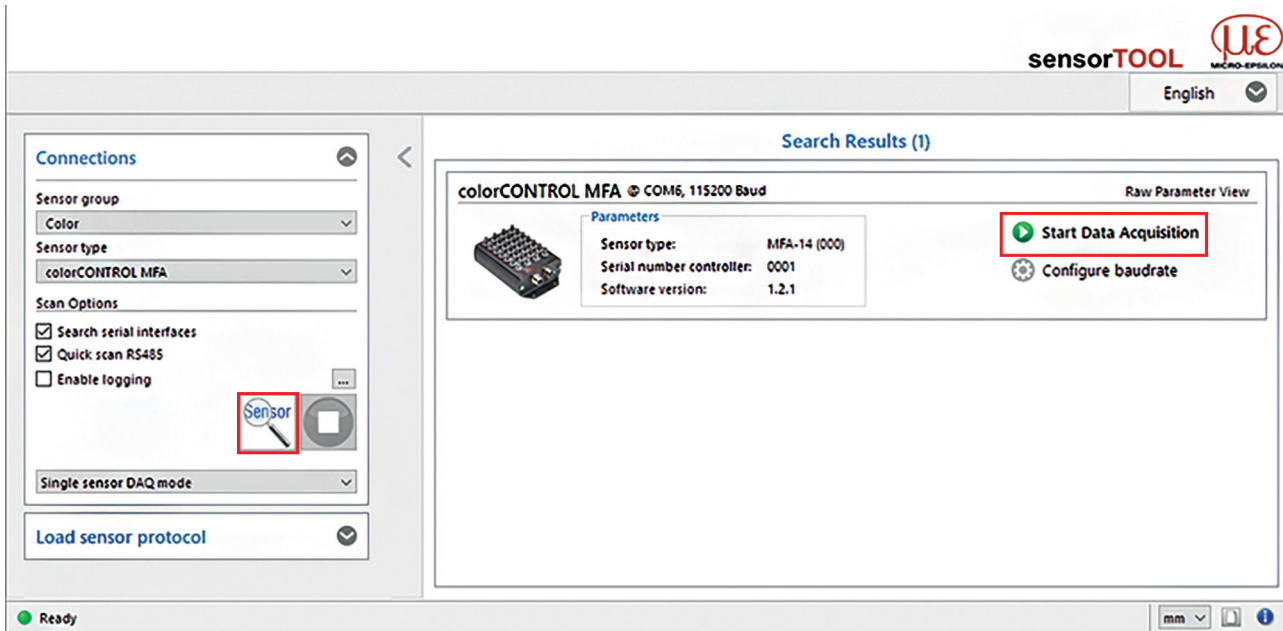

Fig. 6 Sensor search with the sensorTOOL program

- ▶ Click on the `Configure baud rate` button to apply the basic settings of the serial interface.

5.3 System Parameterization via sensorTOOL (Settings Menu)

5.3.1 Modulation Setup

➤ Select the `Settings/Modulation` menu.

Before the MFA-7/14/21/28 can deliver meaningful measurement results, its dynamic range must be adjusted to the measurement situation. This is done with the intensity adjustment (modulation).

Via the drop-down menu, it is possible to select whether the dynamic range adjustment (modulation) takes place for all channels, for all activated channels, or for a single channel only.

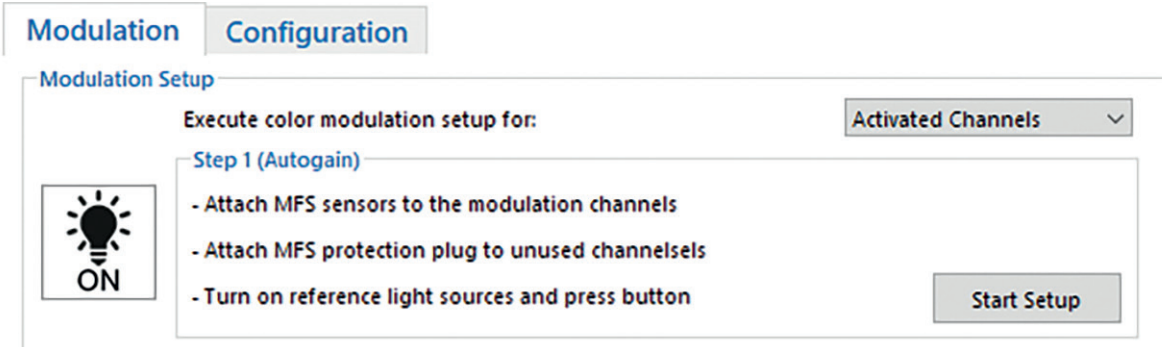

The dynamic range is adjusted (modulation) in three successive steps in the `Settings/Modulation` menu.

➤ Follow the instructions listed under `Step 1 (Autogain)` and click on the `Start Setup` button.

After this step has been completed, a green check mark appears, which indicates that it was successful.

i All channels selected for modulation must be illuminated. For this purpose, it is advisable to select the brightest possible lighting situation such that no underflow or overflow occurs in the receiving detectors. The actual light color is not important, because only the dynamic range in the received brightness (Ix) is adjusted.

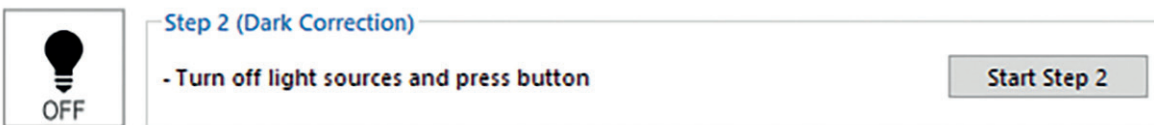

➤ Switch the light source off and click on the `Start Step 2` button.

After this step has been completed, a green check mark appears, which indicates that it was successful.

i In `Step 2 (Dark Correction)`, a dark correction is carried out. None of the channels selected for adjustment may be illuminated during this process.

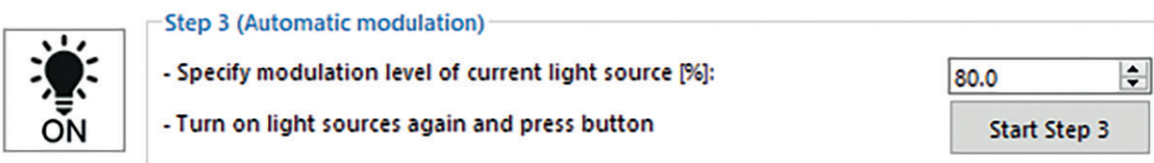

➤ Enter a percentage value, switch the light source on again and click on the `Start Step 3` button.

i Because there are always fluctuations in the production of light sources or because you might not have the correct light source with maximum brightness for the adjustment, you can set a control level in % for the receiver here. If, for example, it is set to 80 %, the light source to be measured can still be 20 % brighter before overflow occurs in the receiver.

After this final step has been completed, you can save the modulation setup either in the working memory using the `Save in RAM` button or in the MFA-7/14/21/28 controller using the `Save permanently` button. If you just want to save it in the RAM, the settings will be lost when you restart the controller and the adjustment will have to be carried out again. However, you can permanently save the settings under `Settings/Configuration` later.

5.3.2 Configuration

➡ Select the Settings/Configuration menu.

In this menu, you can apply settings for the transmission of measured values, as well as for the color space, data rate, color temperature and dominant wavelength. Furthermore, you can load and save the settings and adjust the exposure time, amplification and averaging function for each individual channel.

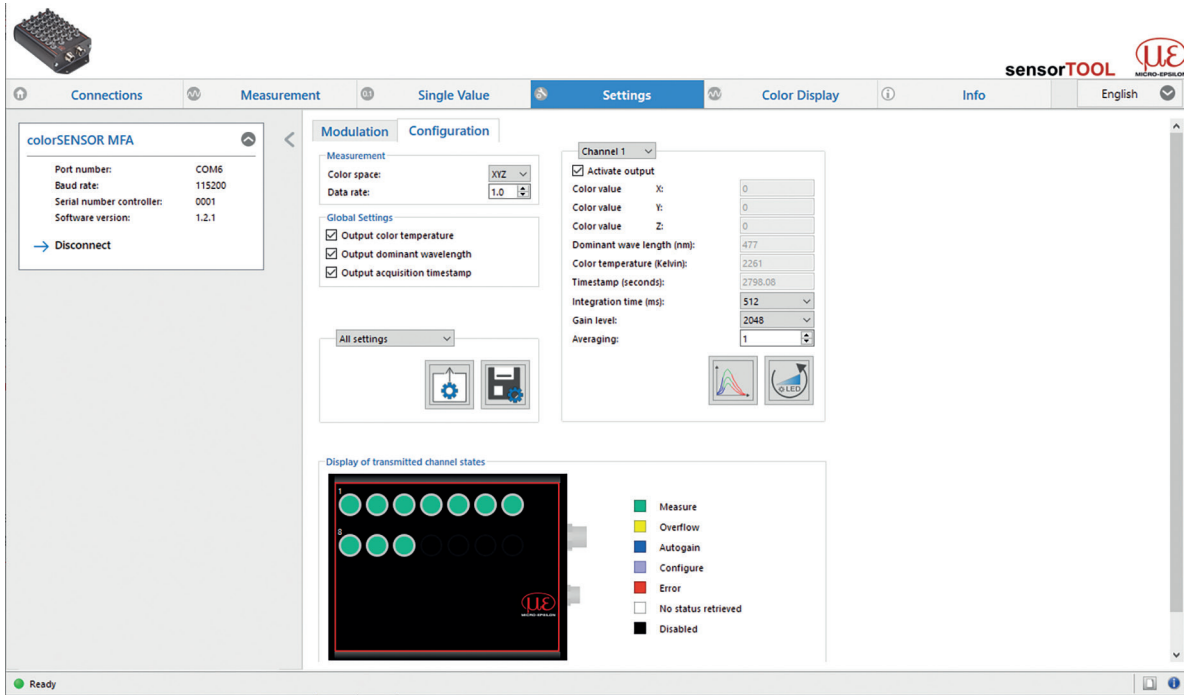
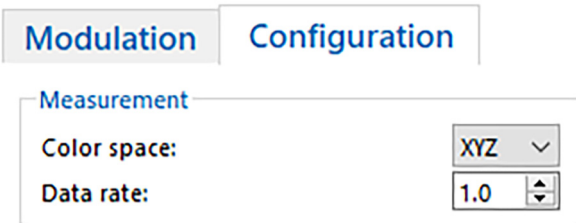

Fig. 7 View of Settings/Configuration menu

5.3.2.1 Configuration/Measurement



Under Configuration/Measurement, you can set the color space and data rate to be used for measurement and output for all channels at once.

Measurement	Color space	XYZ / xyY / Luv / uvL / RGB	Only one color space can be selected and output for all channels at the same time.
	Data rate	Value	The maximum permissible data rate depends on the baud rate set, the number of measuring channels selected, and whether the color temperature CCT and dominant wavelength λ_d have also been selected for transmission under Configuration/Global Settings. The color temperature CCT and dominant wavelength λ_d take longer to calculate, thus reducing the possible data rate many times over.



Fields with gray background require a selection.



Value

Fields with dark border require entry of a value.

5.3.2.2 Global Settings

In the submenu Configuration/Global Settings, you can activate or deactivate the measured values color temperature, dominant wavelength and acquisition timestamp for all measuring channels at once.

Global Settings

- Output color temperature
- Output dominant wavelength
- Output acquisition timestamp

Global settings	Output color temperature	Outputs the color temperature for each active measuring channel in Kelvin.
	Output dominant wavelength	Indicates the dominant wavelength for each active measuring channel in nanometers.
	Output acquisition timestamp	A timestamp documents the time of the measurement.



Fields with gray background require a selection.



Value

Fields with dark border require entry of a value.

5.3.2.3 Channel Overview

Settings can be applied to each individual measuring channel in the Channel Overview submenu.

Channel 1
▼

Activate output

Color value X:

Color value Y:

Color value Z:

Dominant wave length (nm):

Color temperature (Kelvin):

Timestamp (seconds):

Integration time (ms):

Gain level:

Averaging:

Name	Value	Description
Channel 1...28		You can switch between the available measuring channels via the drop-down menu.
Activate output		The channel can be activated or deactivated by checking <code>Activate output</code> .
Color value		Displays the color values depending on the selected color space (XYZ, xyZ, Luv, uvL and RGB)
Dominant wavelength (nm):		Displays the dominant wavelength in nanometers.
Color temperature (Kelvin):		Displays the color temperature in Kelvin.
Timestamp (seconds):		Timestamp for the measuring channels since sensor start-up
Integration time (ms):	1, 2, 4, 8, 16, 32, 64, 128, 256, 512, 1024, 2048, 4096, 8192, 16384	You can set a value for the <code>Integration time</code> via the drop-down menu. By adjusting the sensitivity (modulation), the optimal integration time for the lighting situation of the receiver can be determined. If the selected setting does not appear to be optimal, the value for the integration time can be adjusted via the drop-down menu.
Gain level:	1, 2, 4, 8, 16, 32, 64, 128, 256, 512, 1024, 2048	By adjusting the sensitivity (modulation), the optimal amplification value for the lighting situation of the receiver can be determined. If it does not appear to be optimal, it can be adjusted via the drop-down menu.
Averaging:	Value	Choose the number of values to be used for forming a moving average.

Fields with gray background require a selection. *Value* Fields with dark border require entry of a value.

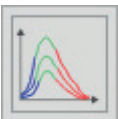

By clicking on the button, a sensible combination of the parameters `Integration time` and `Gain level` is determined automatically for the selected channel.



This button can be used to reset the intensity adjustment for the current channel.

5.4 Measurement Menu

➡ Switch to the Measurement menu.

The data is recorded in a simple manner so that you can review your measurements.

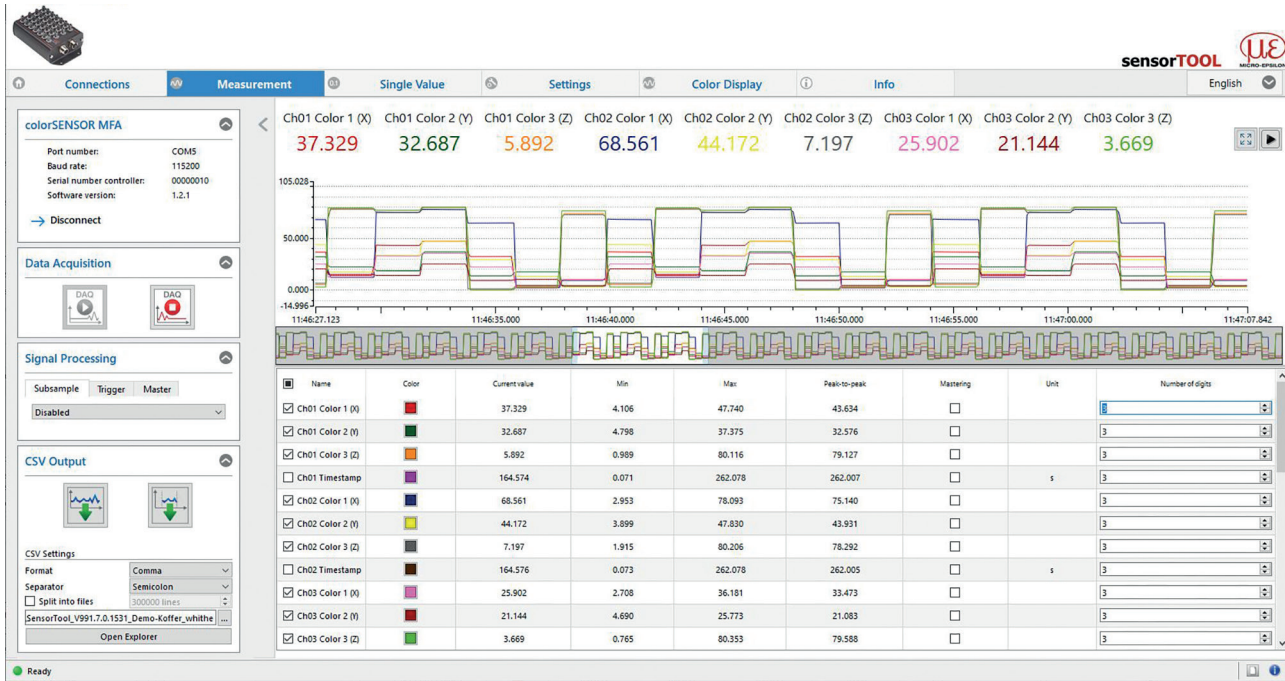

Fig. 8 Measurement view (Measurement menu) in the sensorTOOL program

	➡ Click on the Reset scaling button to reset the Y scale to the original setting (e.g. after zoom).
	➡ Click on the Jump to current time button to display the current signal curve.

5.4.1 Data Acquisition

Using the Data Acquisition buttons, you can start and stop the time graph in which the selected measurement data is being displayed. When data acquisition is stopped, the time graph curve is reset (deleted). Data acquisition starts automatically when you switch to the Data Acquisition menu.

Data acquisition		➡ Click on the button to start the data acquisition.
		➡ Click on the button to stop the data acquisition.

5.4.2 Signal Processing

If you want the data acquisition to take place at a particular point in time rather than continuously, or if you only want to record a specific number of measurement values, you can apply this in the Signal Processing menu, see Fig. 9.

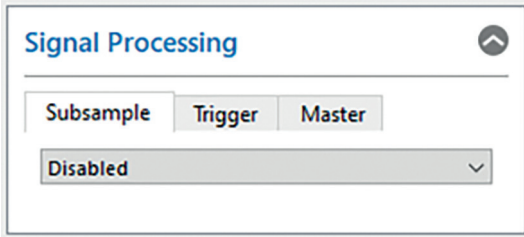

Fig. 9 Detail from Signal Processing menu

Signal processing	Subsample	Disabled			Disabled; default setting
		Sample-based	Measured values	Value	The number of samples can be set; every xth measurement is recorded.
		Time-based	ms, s, min, h, d	Value	Time-based; the time can be set within the millisecond range 1
	Trigger	Disabled			Disabled; default setting
		Continuous	Trigger		Manual trigger
		One-shot (sample-based)	Measured values	Value	The sample can be set; records the signal curve according to the samples set; the more samples there are, the longer the curve.
			Trigger		
	One-shot (time-based)	ms	Value	Milliseconds can be set; records the signal curve according to the set time.	
		Trigger			
	Master	Master now	Sets the master. The button only becomes active when the <code>Mastering</code> check box in the data acquisition table is activated, see 5.4.3. Mastering only affects the measured values displayed in sensorTOOL. It has no effect on the measured values output by the MFA controller.		
Reset		Resets the master.			

Fields with gray background require a selection. Value Fields with dark border require entry of a value.

5.4.3 Data Acquisition Table

Here you can select the measurement data to be displayed in the time graph as well as the number of decimal places for said data.

<input checked="" type="checkbox"/>	Name	Color	Current value	Min	Max	Peak-to-peak	Mastering	Unit	Number of digits
<input checked="" type="checkbox"/>	Ch01 Color 1 (X)		2.890	2.845	2.906	0.061	<input checked="" type="checkbox"/> 0.00		3
<input checked="" type="checkbox"/>	Ch01 Color 2 (Y)		3.425	3.382	3.443	0.060	<input checked="" type="checkbox"/> 0.00		3
<input checked="" type="checkbox"/>	Ch01 Color 3 (Z)		16.732	16.649	16.782	0.134	<input checked="" type="checkbox"/> 100.00		3
<input checked="" type="checkbox"/>	Ch01 Temperature		3593.000	3071.000	4610.000	1539.000	<input type="checkbox"/>	K	3
<input checked="" type="checkbox"/>	Ch01 Wavelength		479.000	479.000	479.000	0.000	<input type="checkbox"/>	nm	3
<input checked="" type="checkbox"/>	Ch01 Timestamp		102.474	69.538	101.506	31.968	<input type="checkbox"/>	s	3

Fig. 10 Detail from table

Name	Here you can show and hide signal curves for the channels.
Color	Here you can change the color settings for the individual curves.
Current value	Displays current measured value.
Min	Minimum of determined measured value.
Max	Maximum of determined measured value.
Peak-to-peak	Difference between min. and max.
Mastering	By activating the <code>Mastering</code> check box, see Fig. 10, the master value can be manually entered. The master values are set using <code>Master now</code> in the <code>Master</code> tab in the <code>Measurement > Signal Processing</code> menu, see Fig. 9. Select a sensible value within the range of -1000 to +1000.
Unit	Selection of the output to be displayed. The outputs are set beforehand in the <code>Settings</code> menu under <code>Output / Output range and adjustment</code> .
Decimal places	0 - 12

Fig. 11 Data acquisition table

5.4.4 Recording and Saving Measurement Data

During data acquisition, the measurement data is only displayed and not automatically saved on the PC. However, in the CSV output, you can start transmitting data into a *.CSV file or save just the current visible region of the time graph.

	Click on this button to start recording measurement data.
	Click on this button to save the current measurement value selection.

Data acquisition	CSV output	Format	Point / comma
		Separator	Comma / semicolon / tab

Fields with gray background require a selection. *Value* Fields with dark border require entry of a value.

5.5 Single Value Menu

➡ Switch to the Single Value menu.

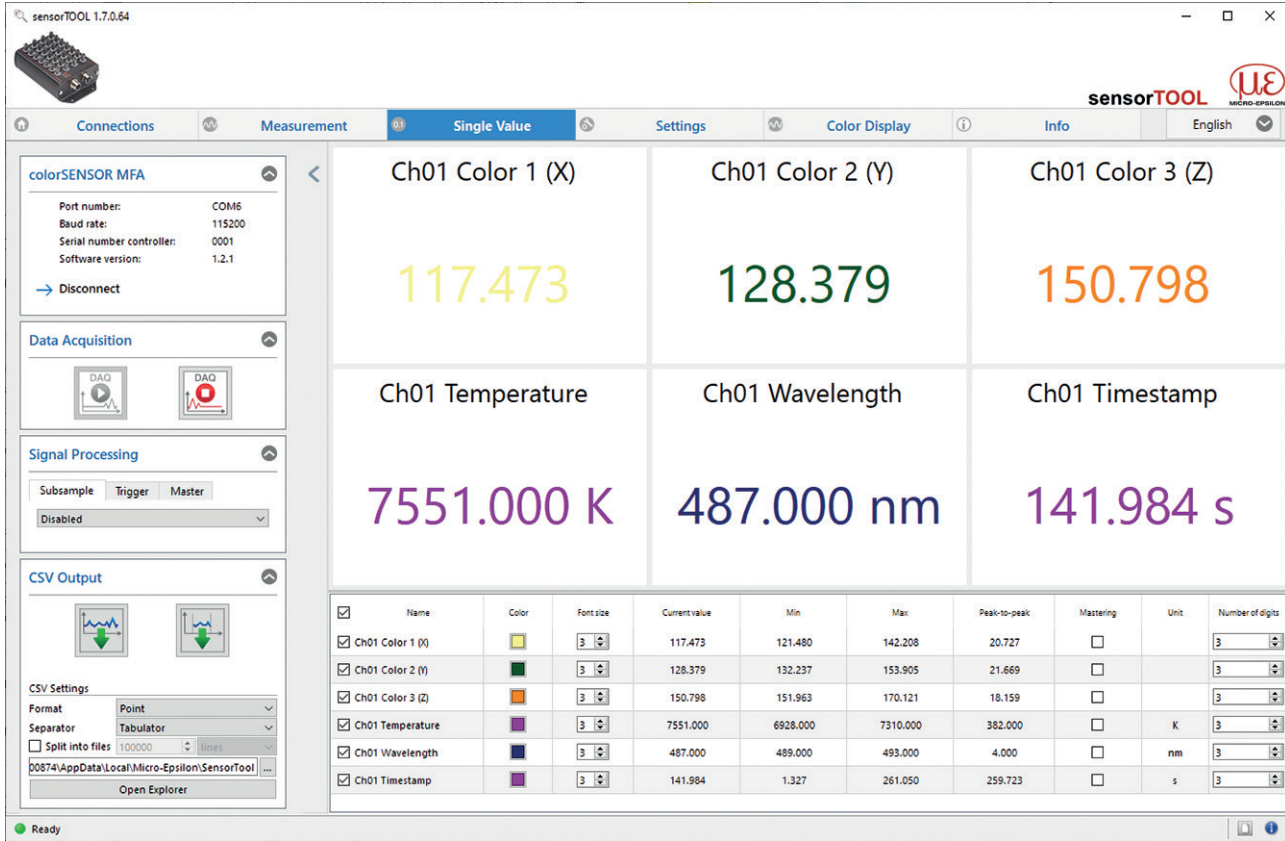

Fig. 12 Measurement view (Single Value menu) in the sensorTOOL program

In this menu, you can view the display of up to 9 measured values in an enlarged view. The measured values can be selected by activating them in the list.

5.6 Color Display Menu

➤ Launch the Color Display menu.

In this menu, you can select from various representations of the measured values and your associated color values.

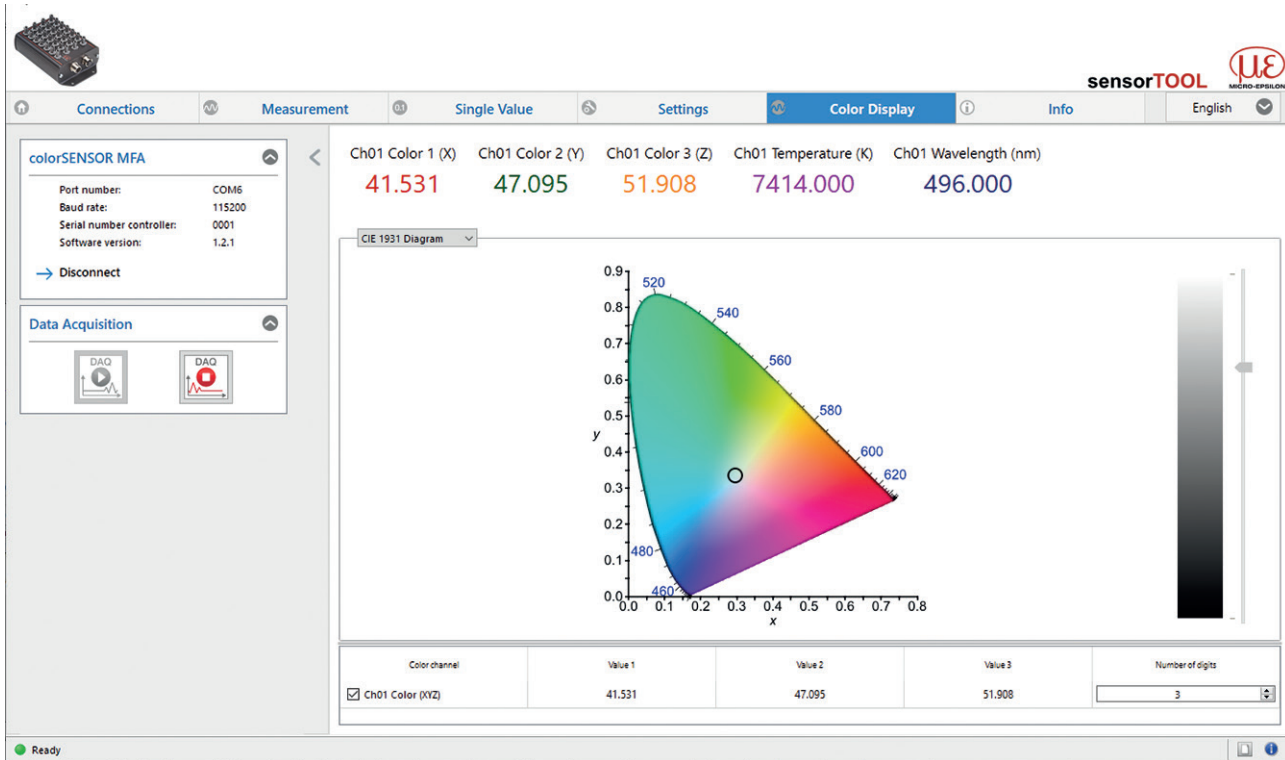

Fig. 13 Color display CIE 1931

You can use the drop-down menu to switch between the four types of graph CIE 1931 color display, rectangular color display, circular color display and MFA color channels.

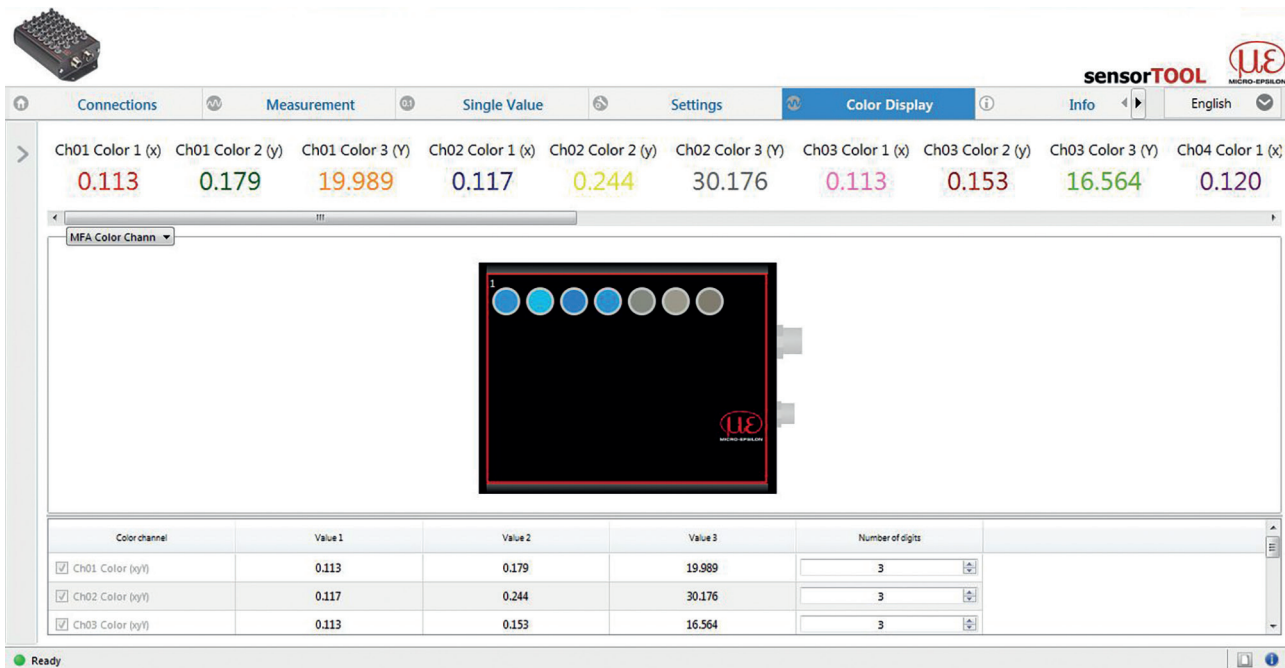

Fig. 14 MFA color channels color display

In the MFA color channels graph, you are shown the color values and your colors for each active measuring channel (depending on your monitor calibration settings). When you move the cursor over the individual channels, you will get a tooltip with the current measured values in the graph. These values can also be found in the table below the graph.

5.7 Info Menu

➤ Switch to the `Info` menu.

In this view, you get additional information on the associated system (MFA-XX). In addition, you can export or import the settings or copy them to a clipboard, and you can reset the system to factory settings.

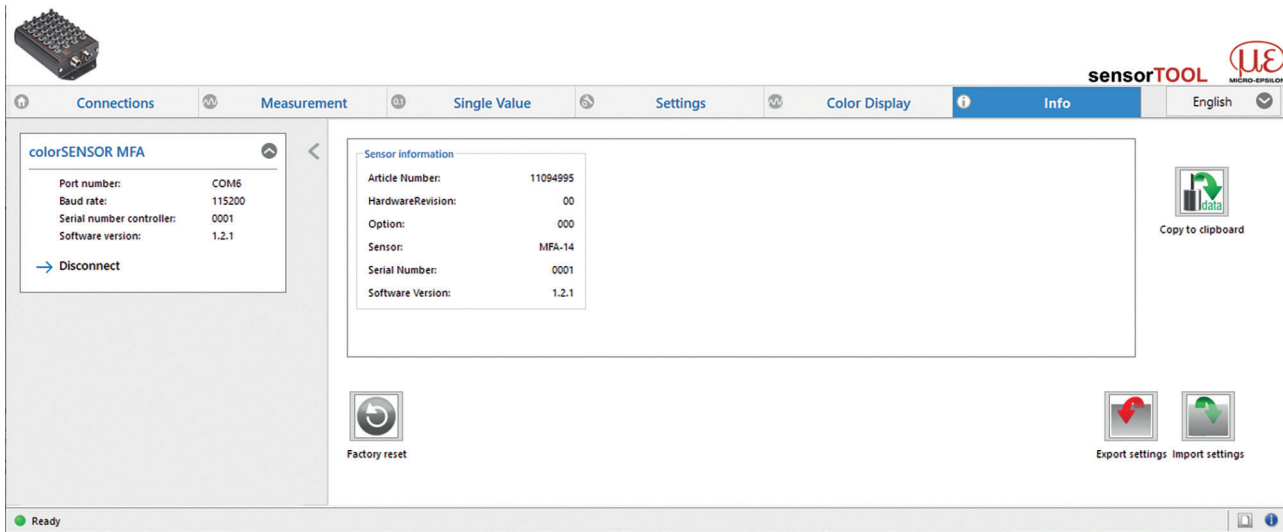

Fig. 15 Info menu view



By clicking on the `Copy to clipboard` button, you can save the information and settings for the selected controller to the clipboard.

When you click the `Disconnect` button, the menu jumps back to the sensorTOOL start page.

5.7.1 Reset to Factory Settings

➤ Go to the `Info` menu and click on the `Factory reset` button.



By clicking on the `Factory reset` button, you can restore the factory settings. All deactivated channels are reactivated, and the intensity adjustments and specially applied channel-related settings are reset.

➤ Confirm the dialog window that then appears with `Yes` to reset the controller.

5.7.2 Export / Import Settings

All controller settings can be saved permanently in parameter sets.



`Export settings` will open the Explorer and give you the option of saving the controller settings in a default *.csv file on the PC.



`Import settings` will open the Explorer and give you the option of importing controller settings from a default *.csv file on the PC.

i We recommend that you always back up the current settings externally on your computer after you have set up the system.

5.7.3 Disconnecting

Here you will find general information about the connected controller.

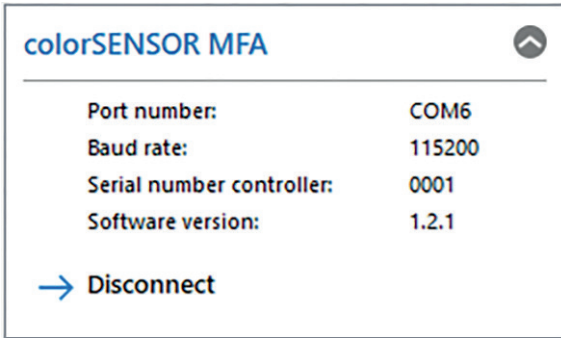

Fig. 16 Disconnect view

By clicking on the `Disconnect` button, you can jump back to the controller search, see Fig. 16, from any menu.

6. Serial Interface (RS422, RS232 and USB)

The RS422 interface has a maximum baud rate of 230400 baud. The baud rate is set to 115200 as default. The measuring rate is at most 100 Hz and depends on the integration time and selected settings. Configuration takes place via ASCII commands or via `sensorTOOL`.

The MFA-XX measures the colors in an internally asynchronous manner and delivers the results at fixed points in time (`DATARATE` command) as a data frame. A data frame consists of 1 to 28 data channels (`OUT` command). Each channel transmits a color and additional values. The additional values can also be set with the `OUT` command for all channels at once. A color is composed of three values, which depend on the selected color space (`COLORSPACE` command). The transmission settings of the controller and of the PC must match.

Data format: Binary format for measured values, commands as ASCII character string
 Interface parameters: 8 data bits, no parity, one stop bit (8N1)

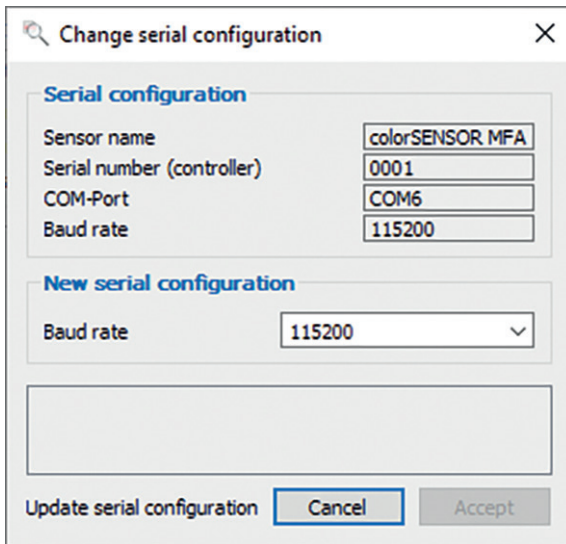

Fig. 17 Change serial configuration window

In `sensorTOOL`, you have access to the configuration of the serial interface, see Fig. 17. Chap. 5.2.1 describes how you can get to this window.

You can select between the values 9600, 115200 and 230400 for the baud rate.

Each value is transmitted in 3 data bytes (color or additional value) with 18 useful bits each.

You can find more information on the measurement data format in the appendix , see A 5.

i Only disconnect or connect the sub-D connection between the RS422 and USB converter when no voltage is flowing.

7. Cleaning

We recommend cleaning the sensor at regular intervals.

Dry Cleaning

This can be accomplished with an anti-static lens brush or by blasting the MFS sensors with dehumidified, clean, oil-free compressed air.

Wet Cleaning

Use a clean, soft, lint-free cloth or lens cleaning paper and lens cleaner to clean the lenses. Never use commercially available glass cleaner or other cleaning agents.

8. Software Support with MEDAQLib

MEDAQLib is a documented driver DLL. It allows you to integrate controllers of the colorCONTROL MFA-7/14/21/28 series into existing PC software or a customer's PC software using the following connections:

- RS422 with the cable CAB-M12-8P-co-straight; Xm-PUR; open ends
- RS232 with the cable CAB-M12-8P-co-straight; Xm-PUR; RS232
- USB with the cable CAB-M12-8P-co-straight; 2m-PVC; USB
- RS422/USB converter, [see A 1](#), or
- RS232/USB converter, [see A 1](#).

MEDAQLib

- contains a DLL that can be imported into C, C++, VB, Delphi and many other programs,
- takes care of data conversion for you,
- works regardless of the type of interface used,
- uses the same functions for communication (commands),
- provides a single transmission format for all MICRO-EPSILON sensors.

For C/C++ programmers, an additional header file and a library file are integrated into MEDAQLib. You can find the current driver routine including documents at:

www.micro-epsilon.com/download

www.micro-epsilon.com/link/software/medaqlib

9. Disclaimer

All components of the device have been checked and tested for functionality in the factory. However, should any defects occur despite careful quality control, these shall be reported immediately to MICRO-EPSILON or to your distributor / retailer.

MICRO-EPSILON undertakes no liability whatsoever for damage, loss or costs caused by or related in any way to the product, in particular consequential damage, e.g., due to

- non-observance of these instructions/this manual,
- improper use or improper handling (in particular due to improper installation, commissioning, operation and maintenance) of the product,
- repairs or modifications by third parties,
- the use of force or other handling by unqualified persons.

This limitation of liability also applies to defects resulting from normal wear and tear (e.g., to wearing parts) and in the event of non-compliance with the specified maintenance intervals (if applicable).

MICRO-EPSILON is exclusively responsible for repairs. It is not permitted to make unauthorized structural and / or technical modifications or alterations to the product. In the interest of further development, MICRO-EPSILON reserves the right to modify the design.

In addition, the General Terms of Business of MICRO-EPSILON shall apply, which can be accessed under Legal details | Micro-Epsilon <https://www.micro-epsilon.com/impressum/>. For translations into other languages, the German version shall prevail.

10. Service, Repair

If the controller or sensor is defective:

- If possible, save the current sensor settings in a parameter set , see [5.7.2](#) to reload them into the controller after the repair.
- Please send us the affected parts for repair or exchange.

If the cause of a fault cannot be clearly identified, please send the entire measuring system to:

MICRO-EPSILON Eltrotec GmbH
Manfred-Wörner-Straße 101
73037 Göppingen / Germany

Tel: +49 (0) 7161 / 98872-300
Fax: +49 (0) 7161 / 98872-303
eltrotec@micro-epsilon.com
www.micro-epsilon.com

11. Decommissioning, Disposal

In order to avoid the release of environmentally harmful substances and to ensure the reuse of valuable raw materials, we draw your attention to the following regulations and obligations:

- Remove all cables from the sensor and/or controller.
- Dispose of the sensor and/or the controller, its components and accessories, as well as the packaging materials in compliance with the applicable country-specific waste treatment and disposal regulations of the region of use.
- You are obliged to comply with all relevant national laws and regulations.



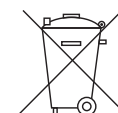

For Germany / the EU, the following (disposal) instructions apply in particular:



- Waste equipment marked with a crossed garbage can must not be disposed of with normal industrial waste (e.g. residual waste can or the yellow recycling bin) and must be disposed of separately. This avoids hazards to the environment due to incorrect disposal and ensures proper recycling of the old appliances.
- A list of national laws and contacts in the EU member states can be found at https://ec.europa.eu/environment/topics/waste-and-recycling/waste-electrical-and-electronic-equipment-weee_en. Here you can inform yourself about the respective national collection and return points.
- Old devices can also be returned for disposal to MICRO-EPSILON at the address given in the imprint at <https://www.micro-epsilon.de/impressum/>.
- We would like to point out that you are responsible for deleting the measurement-specific and personal data on the old devices to be disposed of.
- Under the registration number WEEE-Reg.-Nr. DE28605721, we are registered at the foundation Elektro-Altgeräte Register, Nordostpark 72, 90411 Nuremberg, as a manufacturer of electrical and/or electronic equipment.







Appendix

A 1 Optional Accessories

Name	Photo	Description	Article number
Power supply cable			
CAB-M12-4P-co-fm-straight; 2m-PUR; open ends		Connection cable, 2 m, open ends	11235030
CAB-M12-4P-co-fm-straight; 5m-PUR; open ends		Connection cable, 5 m, open ends	11235031
CAB-M12-4P-co-fm-straight; 10m-PUR; open ends		Connection cable, 10 m, open ends	11235032
Power supply			
PS2020		Power supply for top-hat rail installation, input 230 VAC, output 24 VDC/2.5 A	2420062
PS2031		Plug-in power pack 24V/24W/ 1A; 2m-PVC; Terminal-2P-BU-ge	2420096
USB cable			
CAB-M12-8P-co-straight; 2m-PVC; USB		USB cable 2 m long	11235025

RS232 cable			
CAB-M12-8P-co-straight; 2m-PUR; RS232		RS232 cable 2 m long	11235027
CAB-M12-8P-co-straight; 5m-PUR; RS232		RS232 cable 5 m long	11235028
CAB-M12-8P-co-straight; 10m-PUR; RS232		RS232 cable 10 m long	11235029
RS422 cable			
CAB-M12-8P-co-straight; 2m-PUR; open ends		Connection cable, 2 m, open ends, for data transmission via RS422	11234722
CAB-M12-8P-co-straight; 5m-PUR; open ends		Connection cable, 5 m, open ends, for data transmission via RS422	11234723
CAB-M12-8P-co-straight; 10m-PUR; open ends		Connection cable, 10 m, open ends, for data transmission via RS422	11234725

Receiver sensor			
MFS-22			10825504
MFS-K04			10825506
MFS-K04-3			10825508
MFS-K04-6			10825510
MFS-K05/90			10825512

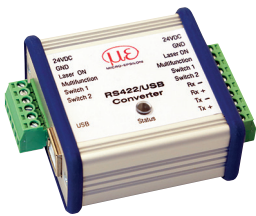
Other accessories			
IF2001/USB		Converter from RS422 to USB, type: IF2001/USB, including driver, Connections: 1x 10-pin socket strip (cable clamp), type: Würth 691361100010; 1x 6-pin socket strip (cable clamp), type: Würth 691361100006	2213025
USB to serial RS232 DB9 adapter black, DIGITUS		Converter from RS232 to USB	6413012

A 2 Factory Settings

Parameter name	Value
Color space:	XYZ
Data rate:	1.0 HZ
Global settings:	Output color temperature: active Output dominant wavelength: active Output acquisition timestamp: active
Integration time (ms):	64
Gain level:	16
Averaging:	1
Measuring channels:	All available measuring channels activated

A 3 Software Update

System requirements for a software update on the controller

➤ Connect the controller to a PC using a direct connection (USB; RS232).

• The parameter settings are not affected by the update. New, additional parameters are set to the default values.

Update

The ZIP file with the current firmware update tool `Update_Sensor.exe` and the firmware can be found on our website at:

<https://www.micro-epsilon.com/download/software/colorCONTROL-MFA-7-serie-Firmware.zip>

If you have any questions, please do not hesitate to get in touch with the relevant sales representative in our team.

A 4 ASCII Communication with Sensor

The ASCII commands can be sent to the controller via the RS422, RS232 or USB interface. All commands, inputs and error reports are in English. A command always consists of the command name and zero or several parameters that are separated with a space and end in LF. If spaces are used in parameters, the parameter must be placed in quotation marks, e.g. "Password with space".

Example: Switching on output via RS422

OUTPUT RS422 ↵

Note: ↵ Must contain LF, but can also be CR LF.

Explanation: LF Line feed (hex 0A)

CR Carriage return (hex 0D)

↵ Enter (depending on system, hex 0A or hex 0D0A)

The currently set parameter value is reset if a command is invoked without parameters.

The output format is:

```
<Command name> <Parameter1> [<Parameter2> [...]]
```

```
<Command name> <Parameter1> <Parameter2> ... <Parameter...>
```

or a combination thereof.

Parameters in [] brackets are optional and require you to enter the preceding parameter. Successive parameters without [] brackets are required, i.e. no parameter can be omitted. Alternative entries for parameter values are separated by "|", e.g. the values "a", "b" or "c" can be set for "a|b|c". Parameter values in <> brackets can be selected from a value range.

Explanations on the format:

"a b"	Parameter value can be set to the value "a" or "b".
" P1 P2"	Both parameters "P1" and "P2" must be set.
" P1 [P2 [P3]]"	The parameters "P1", "P2" and "P3" can be set, whereby "P2" can only be set if "P1" is set and "P3" can only be set if "P1" and "P2" are set.
"<a>"	Parameter value is within a value range of "... to ...", see parameter description.

Parameter values without angle brackets can only be discrete values, see parameter description. Round brackets should be interpreted as a grouping, i.e. for better comprehensibility, "P1 P2|P3" is written as "(P1 P2)|P3".

Example without []:

```
„PASSWD <Old password> <New password> <New password>“
```

- All 3 parameters must be entered in order to change the password.

The output format is:

```
<Command name> <Parameter1> [<Parameter2> [...]]
```

The response can be used again without changes as a command for setting the password. Optional parameters are only returned as well if this is necessary. For example, for the data selection additional values command, only the activated output values are returned.

After a command is processed, a line break and a prompt ("->") is always returned. In the event of an error, an error message beginning with "Exxx", where xx stands for a unique error number, comes before the prompt. Moreover, instead of error messages, warning messages ("Wxxx") may be output. Warnings are structured analogously to error messages. In the case of warning messages, the command has been executed.

For support requests regarding the sensor, the responses to the commands GETINFO and PRINT are helpful because they contain the sensor settings.

A 4.1 Commands Overview

Group	Chapter	Command	Brief information
System			
	Chap. A 4.2.1	HELP	Help on commands
	Chap. A 4.2.2	GETINFO	Request sensor information
	Chap. A 4.2.3	STATUS	Output of information via individual or all measuring channels
	Chap. A 4.2.4	PRINT	Output of all sensor settings
	Chap. A 4.2.5	PRINT ALL	Output of measurement settings and sensor information
	Chap. A 4.2.6	GETCHANNELCNT	Indicates number of available channels
	Chap. A 4.2.7	BASICSETTINGS	Load/save device settings
	Chap. A 4.2.8	MEASSETTINGS	Load/save measurement settings
	Chap. A 4.2.9	RESET	Reboot sensor
	Chap. A 4.2.10	RESETCNT	Reset counter
	Chap. A 4.2.11	SETDEFAULT	Factory settings
Communication			
	Chap. A 4.3.1	BAUDRATE	Set transmission rate of serial interface
	Chap. A 4.3.2	OUTPUT	Activate or deactivate measured value output stream
	Chap. A 4.3.3	DATARATE	Set the data rate for synchronous data output
	Chap. A 4.3.4	OUT	Selection of output values for serial interface
	Chap. A 4.3.5	GETOUTINFO	Listing of output values of serial interface
Adjustment / Reference			
	Chap. A 4.4.1	DARKCORR	Sets the dark correction based on the current measurement.
	Chap. A 4.4.2	DARKCORR_OFFSET	Manual setting or querying of current dark correction
	Chap. A 4.4.3	WHITECORR	Sets a white correction based on the current measured value.
	Chap. A 4.4.4	WHITECORR_FACTOR	Adapts the dynamic range (receiving sensitivity) to the required measuring situation
Measurement			
	Chap. A 4.5.1	AUTOGAIN	Automatic determination of a sensible combination of integration time and amplification in order to obtain the best possible range of values
	Chap. A 4.5.2	GAIN	Setting the gain level
	Chap. A 4.5.3	INTEGRATIONTIME	Set exposure time
	Chap. A 4.5.4	AVERAGING	Set moving average of measured values
	Chap. A 4.5.5	COLORSPACE	Setting a color space for output
	Chap. A 4.5.6	GETMEASURE	Output of a measurement result for selected channels

A 4.2 System

A 4.2.1 HELP

HELP [<command>]

Output help for each command.

Command without parameters

<Command> // Command is executed

Command with parameters

<Command>

// Show current parameter values

<Command> <Parameter1> [<Parameter2> [...]]

// Set the parameters; the number of parameters varies

<Command> <Parameter1> <Parameter2> ... <Parameter...>

// Set the parameters; the number of parameters stays the same

Response to a command

-> Cursor; the sensor is waiting for an entry

E<ddd> Error message; execution rejected

<ddd> Error code

Format explanation

() Grouping

[] Optional parameters

<> Placeholders

| Alternative

If a parameter contains spaces, they must be placed in quotation marks.

Examples:

a|b // Use a or b

a b // Both parameters are required

a [b [c]] // Non-fixed number of parameters: a, a b, or a b c

A 4.2.2 GETINFO, Sensor Information

GETINFO

Request sensor information. Output see example below:

->getinfo		
GETINFO		
Name:	MFA-7	//Model name
Serial:	1001	//Serial number
Option:	000	//Sensor option number
Article:	11094994	//Sensor article number
Version:	1.2.3	//Software version
Hardware-rev:	1.1	
->		

A 4.2.3 STATUS

```
STATUS ALL|CH
```

Provides information about the status of the sensor, such as Measure, Overflow, Error.

->status all
STATUS
STATUS CH01 MEASURE
...
STATUS CH28 MEASURE

A 4.2.4 PRINT, Sensor Settings

```
PRINT
```

Print is used to output all measurement settings. Example of a response:

BAUDRATE 115200
GETCHANNELCNT 14
COLORSPACE XYZ
DATARATE 1.0
OUTPUT ON
OUT CH01 CH02 CH03 CH04 CH05 CH06 CH07 TEMPERATURE WAVE- LENGTH TIMESTAMP

A 4.2.5 PRINT ALL

```
PRINT ALL
```

This command combines the GETINFO, PRINT, GETOUTINFO and STATUS commands. Furthermore, all values from DARKCORR_OFFSET and WHITECORR_FACTOR are output. In addition to the current measurement settings, the sensor information is also output.

-> print all	DARKCORR_OFFSET
PRINT	...
BAUDRATE 115200	WHITECORR_FACTOR
GETCHANNELCNT 28	...
COLORSPACE XYZ	INTEGRATIONTIME
DATARATE 100.0	...
OUTPUT ON	GAIN
OUT CH01 CH02 CH03 CH04 CH05 CH06 CH07 TIMESTAMP	...
GETINFO	AVERAGING
Name: MFA-28	...
Serial: 0007	
Option: 000	
Article: 11094997	
Version: 1.2.1	
Hardware-rev: 00	
GETOUTINFO	->
...	
STATUS	
...	

A 4.2.6 GETCHANNELCNT

GETCHANNELCNT

Indicates the number of current channels.

A 4.2.7 BASICSETTINGS

BASICSETTINGS READ | STORE

READ: Loads the saved, global settings from the permanent memory.

STORE: Saves the global settings in the permanent memory.

A 4.2.8 MEASSETTINGS

MEASSETTINGS READ | STORE

READ: Loads the saved measurement settings from the permanent memory.

STORE: Saves the measurement settings in the permanent memory.

A 4.2.9 RESET, Rebooting Sensor

RESET

The sensor is restarted.

A 4.2.10 RESETCNT, Resetting Counter

RESETCNT TIMESTAMP

Resets the internal timestamp in the sensor.

A 4.2.11 SETDEFAULT

SETDEFAULT ALL | MEASSETTINGS | BASICSETTINGS

Resets the controller to factory settings

ALL: Load standard settings for all settings.

MEASSETTINGS: Load default settings for measurement settings.

BASICSETTINGS: Load default settings for basic settings.

A 4.3 Communication

A 4.3.1 BAUDRATE

BAUDRATE [9600|115200|230400]

Retrieve or set the baud rate for the serial interface.

A 4.3.2 OUTPUT

OUTPUT [NONE|ON]

Switch transmission of the measurement data stream on or off.

A 4.3.3 DATARATE

DATARATE <value>

Retrieve or set the data rate to be used when the measurement data stream is activated (in Hz, one decimal place, 0 < value <= 100).

A 4.3.4 OUT

OUT [CH<d><d> ...] [TEMPERATURE] [WAVELENGTH] [TIMESTAMP]

Select the output values for the serial interface, such as the channel numbers (CH01 ... CH28, temperature, wavelength and timestamp), that are to be output via the measurement data stream.

A 4.3.5 GETOUTINFO

GETOUTINFO

Provides a list of all activated measurement data for transmission in the measurement data stream of the serial interface.

```

->getoutinfo
CH01_COLOR1 CH01_COLOR2 CH01_COLOR3 CH01_TEMPERATURE
CH01_WAVELENGTH CH01_TIMESTAMP
...
CH28_COLOR1 CH28_COLOR2 CH28_COLOR3 CH28_TEMPERATURE CH28_
WAVELENGTH CH28_TIMESTAMP
->

```

A 4.4 Adjustment / Reference

A 4.4.1 DARKCORR

DARKCORR ALL|CH<d><d>

Set the dark reference according to the current measurement.

A 4.4.2 DARKCORR_OFFSET

DARKCORR_OFFSET ALL|CH<d><d> [<float> <float> <float>]

Dark correction: Dark correction is a fixed offset for the three color channels. It should be reset every time the environmental conditions (e.g. ambient light) change significantly. The factory-set standard value is based on a completely insulated (dark) environment.

A 4.4.3 WHITECORR

WHITECORR ALL|CH<d><d>

Set the white factors according to the current light source.

A 4.4.4 WHITECORR_FACTOR

WHITECORR_FACTOR ALL|CH<d><d> [<float> <float> <float>]

White reference: During initial production, each channel of the controller is assigned a set of three factors. This value allows for the correct calculation (regardless of the device) of color positions within the color spaces. The values depend on the optical path (sensors, lenses, angles, distances, etc.). During production, a specific fiber is used to calculate these values.

The white correction factor makes it possible to adapt the dynamic range to the current measuring situation. These factors need to be determined again for this purpose. The dynamic range should be adjusted if the optical setup (e.g. the fibers or the lighting situation) differs significantly from the factory/production environment. In order to reset the white correction factor to factory settings, the value 1 1 1 needs to be set.

A 4.5 Measurement

A 4.5.1 AUTOGAIN

AUTOGAIN ALL|CH

This function determines a sensible combination of integration time and amplification in order to obtain the best possible range of values. The output of the STATUS command displays "AUTOGAIN" for as long as autogain is running. The configuration of the controller should not be changed while the AUTOGAIN operation is being performed.

A 4.5.2 GAIN

GAIN ALL|CH<d><d> [<num>]

Set the hardware amplification level. There are 12 amplification stages from 0 to 11. The amplification stage is $2^{\text{<num>}}$, i.e. the maximum amplification is 2048x.

A 4.5.3 INTEGRATIONTIME

```
INTEGRATIONTIME ALL|CH<d><d> [<num>]
```

Set the hardware integration time. <num> can be 0 to 14, the integration time is $2^{\text{<num>}}$ ms, i.e. the maximum integration time is 16384 ms.

A 4.5.4 AVERAGING

```
AVERAGING ALL|CH<d><d> [<number>]
```

Activate a moving average of the last <numerical> values.

A 4.5.5 COLORSPACE

```
COLORSPACE [XYZ|xyY|Luv|uvL|RGB]
```

Define the color space to be used for the output of color values.

A 4.5.6 GETMEASURE

```
GETMEASURE
```

Provides the latest recorded measurement results for all channels or for the specified channel.

A 4.6 ASCII Error Codes

Error code		Description
E104	ERROR_CODE_TEXTCOMMANDER_HANDLING_RETRY_TIMEOUT	Timeout
E110	ERROR_CODE_CONFIG_PROCESSING_FAILED	Configuration processing failed
E112	ERROR_CODE_TEXTCOMMANDER_HANDLING_HANDLER_ERROR	Error when executing command
E113	ERROR_CODE_AUTOMATIC_WHITE_CORRECTION_FAILED	CHXX indicates the channel in which the error has occurred. When the command is executed for all channels (WHITE-CORR ALL), all faulty channels are displayed (separated by spaces).
E204	ERROR_CODE_TEXTCOMMANDER_HANDLING_INVALID_CHARACTER_ERROR	Invalid character in the input
E210	ERROR_CODE_TEXTCOMMANDER_HANDLING_KEYWORD_ERROR	Unknown command
E214	ERROR_CODE_TEXTCOMMANDER_HANDLING_TOKENIZE_ERROR	The command entered is too long to be processed
E215	ERROR_CODE_TEXTCOMMANDER_HANDLING_OVERFLOW_ERROR	Input or command buffer overflow
E232	ERROR_CODE_TEXTCOMMANDER_HANDLING_PARAMETER_COUNT_ERROR	Incorrect number of parameters
E234	ERROR_CODE_TEXTCOMMANDER_HANDLING_PARAMETER_ERROR	Missing/unexpected parameters or incorrect parameter type
E236	ERROR_CODE_TEXTCOMMANDER_HANDLING_PARAMETER_CONTENT_ERROR	Invalid parameter value
E301	ERROR_CODE_AUTOGAIN_ALREADY_RUNNING	Autogain is already running

A 5 Measurement Data Format

Each value is transmitted in 3 data bytes (color or additional value) with 18 useful bits each.

Conversion is required to output measured values in the various color spaces via RS422. Other values, such as time-stamp, dominant wavelength, trigger and status data, are transmitted as 18-bit data words. Conversion is not required in this case.

Measured value 1:

	Preamble		Data bits					
L-byte	0	0	D5	D4	D3	D2	D1	D0
M-byte	0	1	D11	D10	D9	D8	D7	D6
H-byte	1	0	D17	D16	D15	D14	D13	D12

Measured value 2 ... 168:

	Preamble		Data bits					
L-byte	0	0	D5	D4	D3	D2	D1	D0
M-byte	0	1	D11	D10	D9	D8	D7	D6
H-byte	1	1	D17	D16	D15	D14	D13	D12

Value range for color measurement:

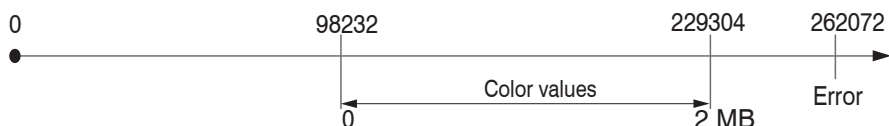

The measured values (integers from 0 ... 262143) converted from three bytes are then scaled:

Scaled color temperature [K] = raw color temperature

Scaled wavelength [nm] = raw wavelength

Scaled timestamp [s] = raw timestamp / 1000

Scaled color = (raw color value – offset) / factor

All values larger than 262072 are error values and are defined as follows:

Error code	Description
262073	Scaling error RS422 interface underflow
262074	Scaling error RS422 interface overflow
262075	Data volume too large for selected baud rate ¹
262076	No peak is present.
262077	Peak is before measuring range (MR)
262078	Peak is after measuring range (MR)
262079	Measured value cannot be calculated

1) This error occurs when more data is to be output than can be transmitted with the selected baud rate at the selected measuring frequency. This can be remedied by:

This can be remedied by:

- changing the baud rate, [see A 4.3.1](#)
- reducing the measuring frequency, [see A 4.3.3](#)

The sequence for a complete data frame (all 168 signals active) is:

Ch01_Color1 Ch01_Color2 Ch01_Color3 Ch01_Temperature Ch01_Wavelength Ch01_Timestamp

Ch02_Color1 Ch02_Color2 Ch02_Color3 Ch02_Temperature Ch02_Wavelength Ch02_Timestamp

...

Ch28_Color1 Ch28_Color2 Ch28_Color3 Ch28_Temperature Ch28_Wavelength Ch28_Timestamp

Deactivated channels are not transmitted and the frame becomes shorter accordingly. The three colors are transmitted in the following order depending on the color space:

Color space	Color1	Color2	Color3
XYZ	X	Y	Z
xyY	x	y	Y
L*u*v*	L*	u*	v*
L*u'v'	L*	u'	v'
RGB	R	G	B

Converting Measured Values to Color Models

When using MEDAQLib, the raw values delivered by the sensor are automatically transferred into the required color space. If MEDIAQLib is not used, the delivered raw data of the sensor itself needs to be converted accordingly. In order to convert the raw values provided by the sensor into a color value, the following formula is used:

$$\text{scaled color} = \frac{\text{raw value} - \text{offset}}{\text{factor}}$$

Different values need to be used for the values for the variable factor and offset depending on the color model into which conversion is to take place. No conversion is required for the color temperature (K) and wavelength (nm).

The values for the factor and offset are listed in the following table.

Factor:	Color1	Color2	Color3
XYZ	1310	1310	1310
xyY	218000	218000	1310
Luv	1310	1190	1190
uvL	1310	218000	218000
RGB	1024	1024	1024

Offset:	Color1	Color2	Color3
XYZ	0	0	0
xyY	21800	21800	0
Luv	0	130900	130900
uvL	20960	21800	21800
RGB	0	0	0

Example:

Converting the raw value into the color space XYZ. For this example, it is assumed that the sensor delivers the following raw values: (226120 ; 0 ; 0)

Conversion into XYZ		
X:	scaled color = $\frac{\text{raw value} - \text{offset}}{\text{factor}}$	scaled color = $\frac{261120 - 0}{1310} = 199.328$
Y:	scaled color = $\frac{\text{raw value} - \text{offset}}{\text{factor}}$	scaled color = $\frac{0 - 0}{1310} = 0$
Z:	scaled color = $\frac{\text{raw value} - \text{offset}}{\text{factor}}$	scaled color = $\frac{0 - 0}{1310} = 0$

Conversion into RGB		
R:	scaled color = $\frac{\text{raw value} - \text{offset}}{\text{factor}}$	scaled color = $\frac{261120 - 0}{1024} = 255$
G:	scaled color = $\frac{\text{raw value} - \text{offset}}{\text{factor}}$	scaled color = $\frac{0 - 0}{1024} = 0$
B:	scaled color = $\frac{\text{raw value} - \text{offset}}{\text{factor}}$	scaled color = $\frac{0 - 0}{1024} = 0$



MICRO-EPSILON Eltrotec GmbH
Manfred-Wörner-Straße 101 · 73037 Göppingen / Germany
Tel. +49 (0) 7161/98872-300 · Fax +49 (0) 7161/98872-303
eltrotec@micro-epsilon.com · www.micro-epsilon.com
Your local contact: www.micro-epsilon.com/contact/worldwide/

X9751434-A012022DTa
© MICRO-EPSILON MESSTECHNIK