



# More Precision.

**Gauges and inspection systems** // Extrusion and calender lines



# Gauges and inspection systems for extrusion and calender lines

## References

References (extract)



**MICRO-EPSILON**

**THE BENCHMARK IN OPTICAL THICKNESS MEASUREMENT  
25 YEARS OF INNOVATION WITH MORE PRECISION**

# Measured features

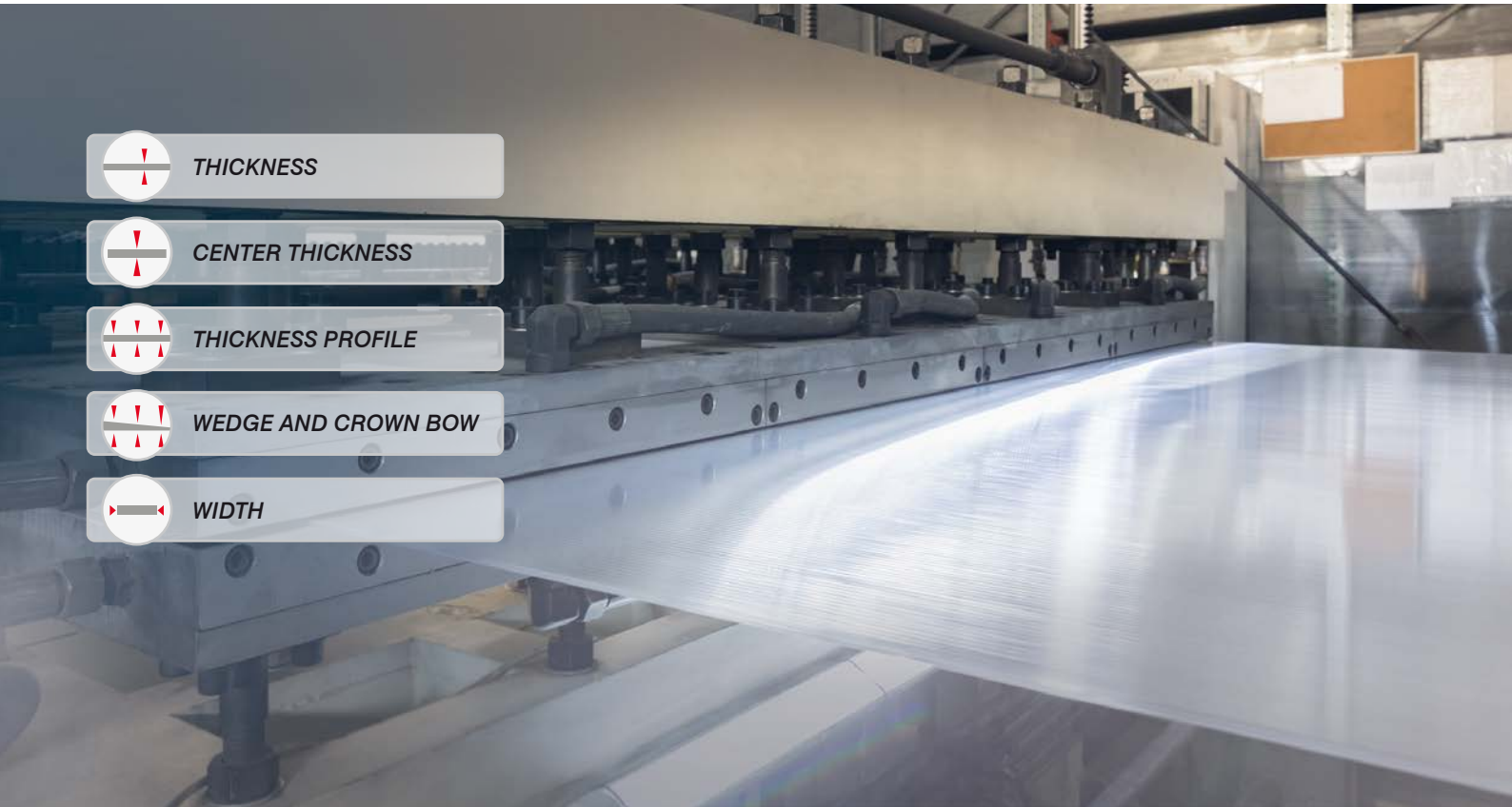

-  **THICKNESS**
-  **CENTER THICKNESS**
-  **THICKNESS PROFILE**
-  **WEDGE AND CROWN BOW**
-  **WIDTH**

## Overview

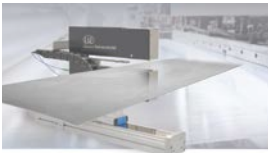

Precise inline thickness measurement  
**thicknessGAUGE C**  
Page 4 - 5



O-frame system with measuring roller  
**thicknessCONTROL STG 8301**  
Page 10 - 11



Precise inline thickness measurement  
**thicknessGAUGE O**  
Page 6 - 7



O-frame system for thickness measurement  
**thicknessCONTROL STG 8101**  
Page 12 - 13



Non-contact thickness measurement  
**thicknessCONTROL STG**  
Page 8 - 9



Wear inspection of the inner diameter of extruder barrels  
**idiamCONTROL**  
Page 14 - 15

# Sensor systems for precise inline thickness measurement

## thicknessGAUGE C

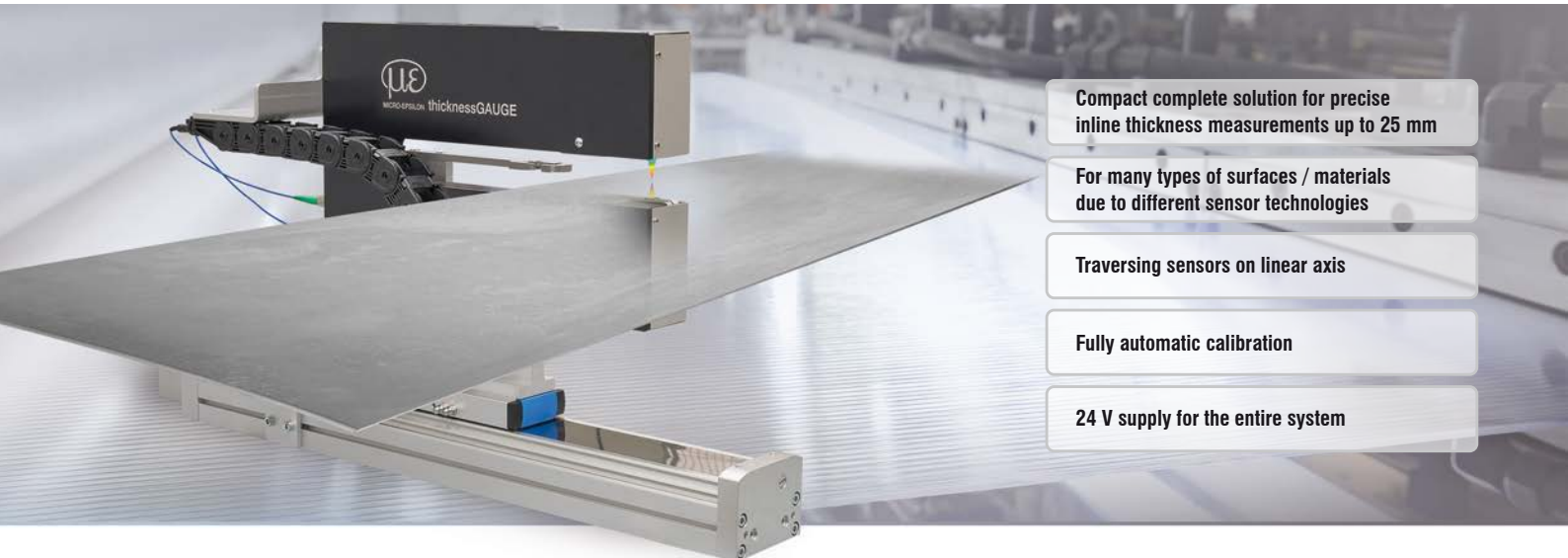

Compact complete solution for precise inline thickness measurements up to 25 mm

For many types of surfaces / materials due to different sensor technologies

Traversing sensors on linear axis

Fully automatic calibration

24 V supply for the entire system

**Thickness measurement with high precision**  
thicknessGAUGE sensor systems are used for precise thickness measurements of strip materials, plates and sheets up to 25 mm. Several models with different sensor types, measuring ranges and measuring widths enable inline thickness measurements of different materials and surfaces based on an unmatched price/performance ratio.

This fully assembled system comprises a stable frame on which two optical sensors are mounted, that detect the thickness of the measuring object according to the difference principle. The sensors are perfectly aligned to each other and calibrated during the assembly. Furthermore, thickness calibration at the factory ensures high precision.

### Operating principle of thickness measurement

The principle of dimensional, geometric thickness measurement includes one optical distance sensor on each side of the material. The distance (=operating range) of both sensors is determined in a calibration process based on a measurement standard certified by DAkkS (German Accreditation Body) of which the thickness is added to the sum of the sensor signals in order to determine the current operating range.

#### Available options:

- Selectable cable lengths
- Customer-specific axis length
- Encoder
- Interface for fieldbus connection
- Digital inputs/outputs

### Automatic calibration and temperature compensation

thicknessGAUGE systems are equipped with in-situ calibration in order to compensate, e.g., for the effects of fluctuating temperatures. A linear axis moves the thicknessGAUGE to the parking position. The calibration cycles are individually adjustable. In addition to temperature compensation, in-situ calibration enables proper functioning of the system to be verified cyclically and at any time.



Fully automatic calibration enables reliable measurements (here: thicknessGAUGE C.LP)

## Technologies



### thicknessGAUGE C.L

Sensor technology used:

- Laser triangulation displacement sensors
- Measuring range (thickness): 10 / 25 mm
- Accuracy:  $\pm 2 / \pm 5 \mu\text{m}$
- Measuring rate: up to 4 kHz

Reasonably priced sensor system for common surfaces from plastics to metals

Compact design meets high performance & excellent price/performance ratio



Model	C.L-10/200	C.L-10/400	C.L-25/200	C.L-25/400
Article no.	4350127.800	4350127.801	4350127.802	4350127.803
Measuring width	200 mm	400 mm	200 mm	400 mm
Measuring range	10 mm		25 mm	
Accuracy <sup>1)</sup>	< ±2 μm <sup>2)</sup>		< ±5 μm <sup>2)</sup>	
Resolution	0.7 μm		3.2 μm	
Repeatability <sup>1)</sup>	±0.3 μm		±0.8 μm	
Material temperature	40 °C		40 °C	

<sup>1)</sup> 2 σ; data valid for diffuse reflecting, metallic measurement standard (DAkkS certified); <sup>2)</sup> Temperature drift: ±0.015 % FSO / K

Model	C.C-2/200	C.C-2/400	C.LP-8/200	C.LP-8/400
Article no.	4350127.900	4350127.901	4350127.700	4350127.701
Measuring width	200 mm	400 mm	200 mm	400 mm
Measuring range	2 mm		8 mm	
Accuracy <sup>1)</sup>	< ±0.4 μm <sup>2)</sup>		< ±0.75 μm	
Resolution	40 nm		0.2 μm	
Repeatability <sup>1)</sup>	±0.15 μm		±0.2 μm	
Material temperature <sup>2)</sup>	40 °C		40 °C	

<sup>1)</sup> 2 σ; data valid for high-gloss, metallic measurement standard (DAkkS certified)

<sup>2)</sup> In case of one-sided measurement ±1 μm

### The new class for inline thickness measurements

thicknessGAUGE sensor systems are used in industrial environments for precise thickness measurements of strip and plate materials. A linear unit with electromechanical drive enables thickness measurements in traversing mode. Alternatively, fixed track measurements are possible for center-line measurements (center thickness) or for thickness measurements on the edges.

These compact systems are comprised of an integrated linear unit including motor control, a compact bus terminal box, an automatic calibration unit as well as a multi-touch PC with pre-installed software. The entire system is powered via a 24 V source.

#### Fixed track center thickness measurement (strip width max. 800 m)

#### Traversing thickness measurement (strip width max. 400 mm)

#### Fixed track measurement on the edges (any strip width)

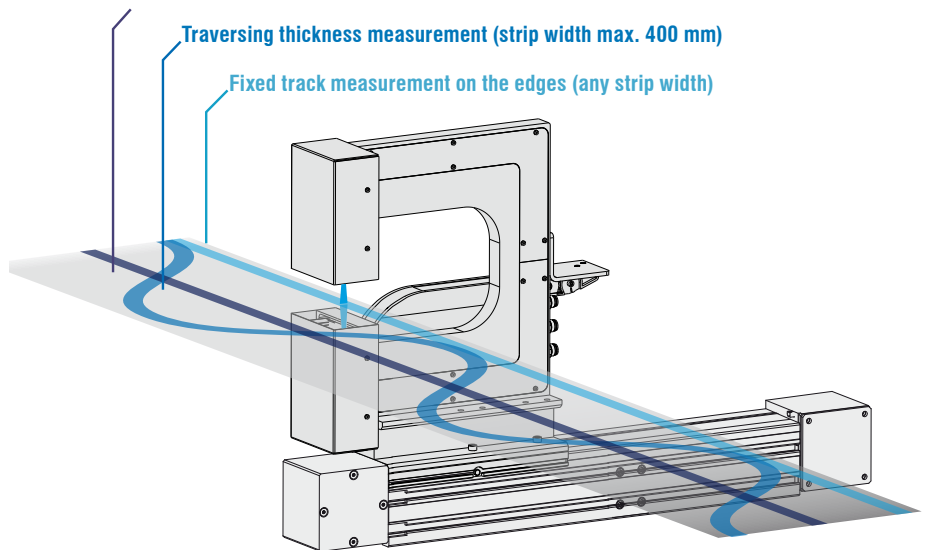

### Technologies

#### thicknessGAUGE C.C

Sensor technology used:  
Confocal chromatic displacement sensors

- Measuring range (thickness): 2 mm
- Accuracy: ±0.4 μm
- Measuring rate: up to 5 kHz

Ideal for high resolution measurements of highly reflective and shiny surfaces

Also for transparent and semi-transparent film



#### thicknessGAUGE C.LP

Sensor technology used:  
Blue Laser profile sensors

- Measuring range (thickness): 8 mm
- Accuracy: ±0.75 μm
- Measuring rate: up to 100 Hz

For structured materials, e.g., perforated and embossed plates

Best-fit line possible

Compensation for tilted strips

# Sensor systems for precise inline thickness measurement

## thicknessGAUGE O



One-sided geometric thickness measurement

Different materials widths up to 1,250 mm

Traversing measurement or fixed track measurement

Comprehensive software package for data acquisition, signal processing and automation

Suitable for OEMs

### The new class for inline film thickness measurements

The thicknessGAUGE O series offers compact inline measuring systems in O-frame or gantry form and is used for precise thickness measurement of non-conductive strip material. These compact systems consist of a stable base frame, an integrated control cabinet and one measuring roller or two guide rollers. Currently, they can be equipped with the combiSENSOR KSS6430 or the interferometer IMS5400MP-DS19.

The combiSENSOR has a concentrically arranged eddy current coil and measurement electrode. Both sensors measure against the same spot. The signal of the capacitive displacement sensor is a function of the working distance, the thickness of the insulator (D) and the dielectric constant of the insulator material ( $\epsilon_r$ ). At the same time, the eddy current displacement sensor measures

the distance to the measuring roller and thus compensates for a change in the working distance of the capacitive sensor during thermal deformation of the measuring frame. The interferometer works with polychromatic white light. The integrated light source uses an extended wavelength spectrum instead of a defined wavelength. Thus, significantly more information is available for the evaluation of the superposition from transmitted and received wavelengths. Multi-peak distance measurement on transparent objects is realized, thin transparent coatings can be measured with high precision.

### Flexible integration into production line

thicknessGAUGE O.EC can generate both a transverse profile of the material thickness in traversing mode, and a longitudinal profile at any width position. The measurement data is displayed on the touch panel IPC included in the scope of supply. Via the optional network

or fieldbus interface, thicknessGAUGE O can be coupled with the production line to automate the measuring operation.



thicknessGAUGE OEC

### Technologies



#### thicknessGAUGE O.EC

Sensor technology used: combiSENSOR capacitive/eddy current

- Measuring range (thickness): 5 mm
- Accuracy:  $\pm 0.3 \mu\text{m}$
- Measuring rate: up to 3.9 kHz

Compact sensor system for one-side measurement of the total thickness of non-conductive materials



### Applications with sensor technology from Micro-Epsilon

Inline color measurement of transparent films using the ACS3 transmission sensor and colorCONTROL ACS7000

#### Advantages:

- Accuracy and high speed for inline integration
- 100% quality control due to automatic and continuous color inspection
- Increase in productivity and reduction of waste

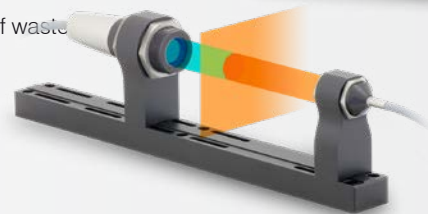

Model	O.EC-5/500	O.EC-5/750	O.EC-5/1000	O.EC-5/1250	O.IMS-5/500	O.IMS-5/750	O.IMS-5/1000	O.imS-5/1250
Article no.	4350123.10	4350123.11	4350123.12	4350123.13	4350123.510	4350123.511	4350123.512	4350123.513
Max. measuring width	500 mm	750 mm	1000 mm	1250 mm	500 mm	750 mm	1000 mm	1250 mm
Measuring range	3 mm				1.4 mm			
Accuracy <sup>1)</sup>	±0.3 μm <sup>2)</sup>				±0.2 μm			
Resolution	0.045 μm				0.001 μm			
Repeatability	±0.06 μm				±0.04 μm			
Material temperature	45 °C				45 °C			

<sup>1)</sup> 2 σ, <sup>2)</sup> ε<sub>r</sub> = 1

### Powerful software

- Visualization of measurement results in numerical form and adjustable display of cross profile and longitudinal profile for ease of use
- Display of either imperial or metric units
- Flexible interface for control signals and process data for production line, especially for length/speed signal (=encoder signal)
- Preconfigured for teleservice via VPN connection
- Integrated, full automatic test of equipment capability
- Based on Windows 10

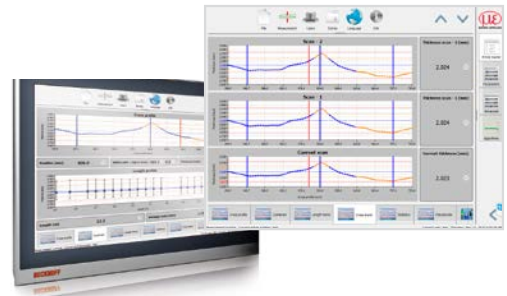

### Technologies



#### thicknessGAUGE O.IMS

Sensor technology used: interferometer

- Measuring range (thickness): 1.4 mm
- Accuracy: ±0.2 μm
- Measuring rate: up to 6 kHz

Compact sensor system for one-sided measurement of the total and layer thicknesses of transparent materials

# Non-contact thickness measurement thicknessCONTROL STG 8102



Wide variety of technologies

Non-contact measurement

Suitable for different materials

Can be equipped for the harshest of environments

Multi-touch human-machine interface

The modularly designed, C-frame based systems of the thicknessCONTROL TCP STG 8102 series impress due to their flexibility, robustness and performance. Their compact design enables to install precise inspection technology also in lines with low packaging space.

### Wide variety of technologies

Either laser point triangulation sensors (ILD), confocal chromatic sensors (K) or laser profile scanners (LLT) are integrated in the lower and upper belts of the C-frame. The result of the measurement is the difference between the sum of the sensor signals and the working gap determined in the calibration. In combination with highly-efficient signal processing algorithms of the analysis and visualization software, accuracies in the micrometer range are reached.

Due to the wide range of technologies that can be used in the thicknessCONTROL STG

8102 series, a wide variety of applications can be realized on a wide range of non-conductive materials, from transparent over glossy to mat black.

### Integration in difficult environments

A fully-automatic in-situ calibration ensures the measurement to be independent from temperature influences, thus the system can be applied in harsh industrial environments being characterized by permanently providing inline precision.

All sensor technologies applied measure without contact, wear-free and without isotopes or X-rays. This process provides long-term reliable measured data while avoiding consequential costs.

The systems are mounted on linear axes. They have electric drives to position them firmly for measuring a longitudinal profile, for example in the middle of the strip material,

or traversing to measure a transverse profile of the material. Furthermore, they can be equipped with cooling and protection units so that they can also be used in harsh environmental conditions.



thicknessCONTROL STG 8102.T

### Technologies



#### thicknessCONTROL STG 8102.T

Sensor technology used: laser triangulation displacement sensors

- Measuring range (thickness): 20 / 50 mm
- Accuracy:  $\pm 4 / \pm 10 \mu\text{m}$
- Measuring width: up to 1000 mm

Robust thickness measuring system for films and plates with simple surfaces

Can be equipped with cooling and pneumatic protective equipment for the optical system for harsh ambient conditions

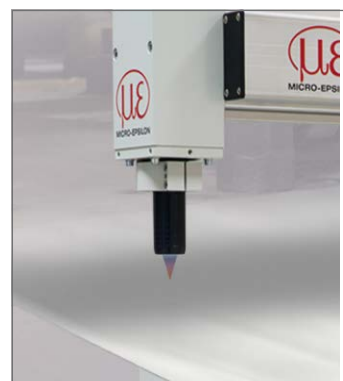



### thicknessCONTROL STG 8102.K

Article no.	4350127.410	4350127.41	4350127.44	4350127.411	4350127.42	4350127.45	4350127.43	4350127.46
Measuring width	250 mm			500 mm			1000 mm	
Measuring range	3 mm	10 mm	30 mm	3 mm	10 mm	30 mm	10 mm	30 mm
Resolution	0.07 $\mu\text{m}$	0.12 $\mu\text{m}$	0.36 $\mu\text{m}$	0.07 $\mu\text{m}$	0.12 $\mu\text{m}$	0.36 $\mu\text{m}$	0.12 $\mu\text{m}$	0.36 $\mu\text{m}$
Accuracy <sup>1)</sup>	$\pm 0.4 \mu\text{m}$	$\pm 0.7 \mu\text{m}$	$\pm 2.5 \mu\text{m}$	$\pm 0.4 \mu\text{m}$	$\pm 0.7 \mu\text{m}$	$\pm 2.5 \mu\text{m}$	$\pm 0.7 \mu\text{m}$	$\pm 2.5 \mu\text{m}$
Repeatability <sup>1)</sup>	$\pm 0.3 \mu\text{m}$	$\pm 0.5 \mu\text{m}$	$\pm 2 \mu\text{m}$	$\pm 0.3 \mu\text{m}$	$\pm 0.5 \mu\text{m}$	$\pm 2 \mu\text{m}$	$\pm 0.5 \mu\text{m}$	$\pm 2 \mu\text{m}$
Material temperature <sup>2)</sup>	up to 70 °C							

<sup>1)</sup> 2  $\sigma$

<sup>2)</sup> without additional cooling

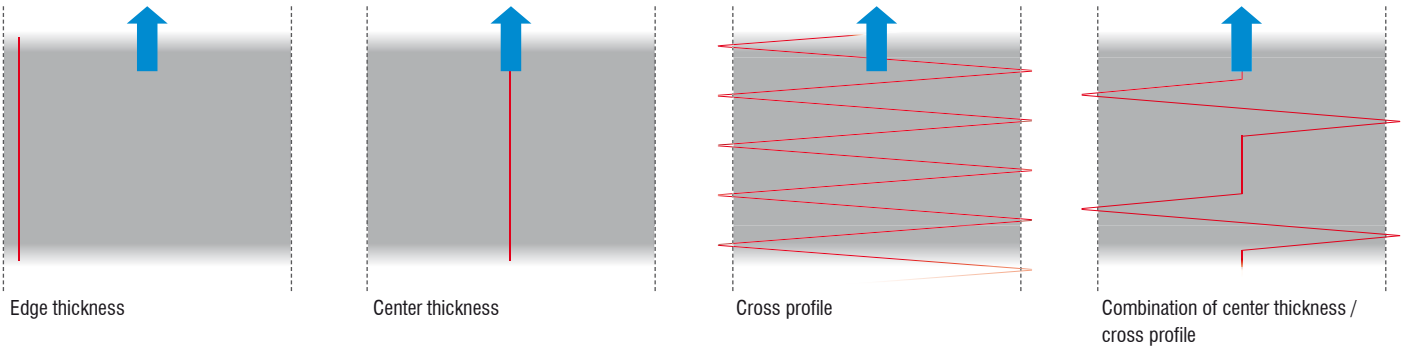

### 1-track measurement mode

When choosing a C-frame, the measurement width plays an important role. If only the edge is to be measured, the smallest measuring width is sufficient. When measuring the center thickness, the measuring width must correspond to 50 percent of the material width. If the cross profile is to be measured, the measuring width must correspond to the maximum material width.

### thicknessCONTROL STG 8102.T/LLT

Article no.	4350127.230	4350127.231	4350127.232	4350127.233	4350127.234	4350127.235	4350127.236	4350127.237
Sensor	Laser point sensor				Laser line sensor			
Measuring width	500 mm		1000 mm		500 mm		1000 mm	
Measuring range	20 mm	50 mm	20 mm	50 mm	50 mm	100 mm	50 mm	100 mm
Resolution	0.45 $\mu\text{m}$	1.1 $\mu\text{m}$	0.45 $\mu\text{m}$	1.1 $\mu\text{m}$	1 $\mu\text{m}$	2 $\mu\text{m}$	1 $\mu\text{m}$	2 $\mu\text{m}$
Accuracy <sup>1)</sup>	$\pm 4 \mu\text{m}$	$\pm 10 \mu\text{m}$	$\pm 4 \mu\text{m}$	$\pm 10 \mu\text{m}$	$\pm 3 \mu\text{m}$	$\pm 7.5 \mu\text{m}$	$\pm 3 \mu\text{m}$	$\pm 7.5 \mu\text{m}$
Repeatability <sup>1)</sup>	$\pm 1.5 \mu\text{m}$	$\pm 3.5 \mu\text{m}$	$\pm 1.5 \mu\text{m}$	$\pm 3.5 \mu\text{m}$	$\pm 1 \mu\text{m}$	$\pm 2 \mu\text{m}$	$\pm 1 \mu\text{m}$	$\pm 2 \mu\text{m}$
Material temperature <sup>2)</sup>	45 °C							

<sup>1)</sup> 2  $\sigma$

<sup>2)</sup> without additional cooling

## Technologies

### thicknessCONTROL STG 8102.K

Sensor technology used: Confocal sensor technology

- Measuring range: 3 / 10 / 20 mm
- Accuracy: 0.4  $\mu\text{m}$  /  $\pm 0.7 \mu\text{m}$  /  $\pm 2.5 \mu\text{m}$
- Measuring width: up to 1000 mm

Highly precise thickness measuring system for thin films with complex surfaces or transparent coatings

Multi-peak functionalities for multiple-layer measurement

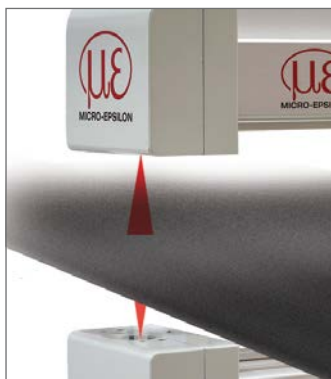

### thicknessCONTROL STG 8102.LLT

Sensor technology used: laser profile scanner

- Measuring range: 60 / 100 mm
- Accuracy:  $\pm 0.3 \mu\text{m}$  /  $\pm 7.5 \mu\text{m}$
- Measuring width: up to 1000 mm

High performance thickness measuring system for thick webs or sheets even for profile thickness measurement

Can be equipped with cooling and pneumatic protective equipment for the optical system for harsh ambient conditions

# O-frame system with measuring roller thicknessCONTROL STG 8101



## Operating principle of thickness measurement

The thicknessCONTROL STG 8101.EO systems are designed as O-frames and impress with their stability and extremely high precision in thickness measurement, especially for large material widths.

## Color-independent thickness measurement

The system measures in traversing mode i.e. the thickness of the material is calculated from two distance signals.

The combination of an eddy current sensor and a ThruBeam sensor is applied on the upper side of the material that is guided over a measuring roller. While the ThruBeam sensor detects the upper side of the material, the eddy current sensor measures the lower side indirectly by means of the surface of the measuring roller. The thickness of the material to be measured results from the difference between the two signals. With the color-independent functioning of the integrated ThruBeam sensor, the system provides highly precise results.

## Suitable for harsh environments

The integration of an efficient, pneumatically operating protective device for the optics of the ThruBeam sensor makes the system insensitive to vapors and particles. An optional tempering of the measuring roller ensures highest precision at high material temperatures. Therefore, the system is ideal for applications in harsh industrial environments.

Furthermore, STG 8101.EO offers efficient operation facilities due to large maintenance-free intervals.

## High degree of coverage

With O-frame shaped measuring systems, only the sensor technology traverses. Since it has only little weight, it can be accelerated quickly to scan correspondingly fast over the material during the traversal measurement. This is particularly favorable for large widths, as a very large number of cross sections can be detected per linear meter of material.



thicknessCONTROL STG 8101.EO

## Technologies

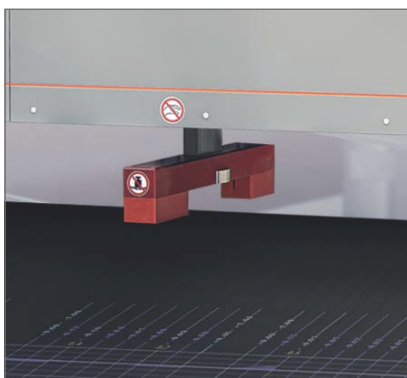

### thicknessCONTROL STG 8101.EO

Sensor technology used: ThruBeam Sensor combined using eddy current sensor and measuring roller

- Measuring range: 10/20 mm
- Accuracy:  $\pm 1 \mu\text{m}$  /  $\pm 3 \mu\text{m}$
- Measuring width: up to 4000 mm (on request)

Thickness measuring system for very large films independent from color and surface

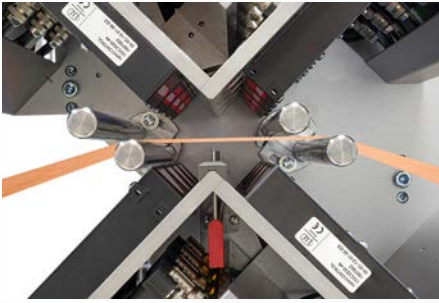

**Applications with sensor technology from Micro-Epsilon**  
 Width measurement of strip materials with ThruBeam sensor ODC 2520

**Advantages:**

- Automatic calibration of the sensor position
- Flexible for different material widths
- High precision

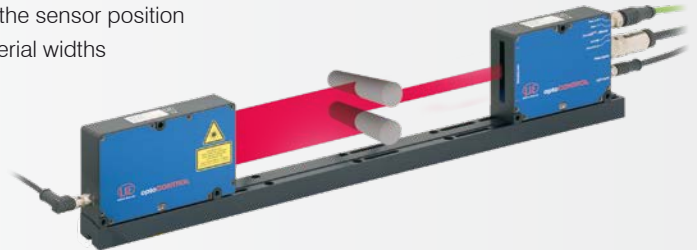

thicknessCONTROL STG 8101.EO								
Article no.	4350039.100	4350039.101	4350039.102	4350039.103	4350039.104	4350039.105	4350039.106	4350039.107
Measuring width	1000 mm	1500 mm	2000 mm	2500 mm	1000 mm	1500 mm	2000 m	2500 mm
Measuring range	10 mm				20 mm			
Resolution	2 $\mu\text{m}$							
Accuracy <sup>3)</sup>	$\pm 1 \mu\text{m}$				$\pm 3 \mu\text{m}$			
Repeatability <sup>1)</sup>	$\pm 0.5 \mu\text{m}$				$\pm 1.5 \mu\text{m}$			
Material temperature <sup>2)</sup>	60 °C							

<sup>1)</sup> 2  $\sigma$   
<sup>2)</sup> Without additional cooling

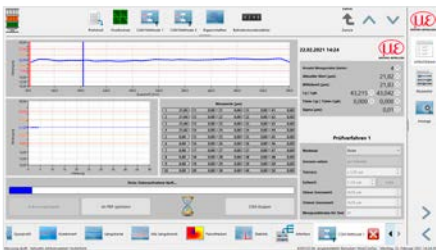

To monitor the functionality and precision of the system, procedure 1 and procedure 3 of the gauge capability test are integrated in the software and can be performed fully automatically.



**Control of calender roller or extruder nozzle**

In addition to the thickness measuring systems, Micro-Epsilon offers both software and hardware for controlling the roller gap in calenders or regulating the nozzle gap via the thermal bolts of the extrusion nozzle.

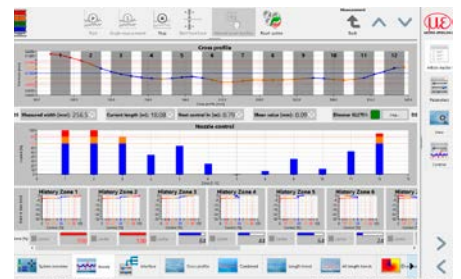

# O-frame system for thickness measurement

## thicknessCONTROL STG 8101



Can be equipped with different sensor technologies

Patented, controlled compensation of thermal effects

Suitable for very thick and large materials

High performance signal processing

Integrable width measurement

### Sturdy system design

The STG 8101.CT/CLLT systems are designed as O-frames with opposing optical sensors. Their impressive precision is based on a harmonized package of sensors, mechanics and software.

### Technical design for harsh industrial environments

The systems measure in traversing mode. The thickness of the material is determined from the difference resulting from the sensor distance and the sum of the sensor signals. The sensor distance is determined in an automatic in-situ calibration that can be performed in seconds.

The sensors integrated on carriages in the lower and upper belt of the O-frame can be equipped with cooling elements and pneumatic protection devices for the optics. This means that the systems can be used at high material temperatures and have a high resistance to vapors and particles. All sensor technologies applied measure without contact, wear-free and without isotopes or X-rays.

### Patented stability

The thicknessCONTROL STG 8101.CT/CLLT series exhibits revolutionary long-term stability in production thanks to its patented compensation concept for temperature-related parasitic effects acting on the mechanics.

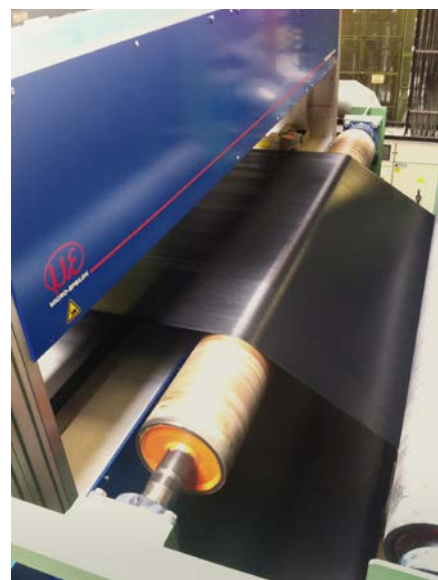

thicknessCONTROL STG 8101.CLLT

### Technologies



#### thicknessCONTROL STG 8101.CT

Sensor technology used: laser triangulation displacement sensors

- Measuring range: 50 mm
- Accuracy:  $\pm 0.5 \mu\text{m}$
- Measuring width: up to 4000 mm (on request)

Robust thickness measuring system for films and plates with simple surfaces

Can be equipped with cooling and pneumatic protective equipment for the optical system for harsh ambient conditions



### Applications with sensor technology from Micro-Epsilon

Blown film thickness measurement

#### Advantages:

- 100 % non-contact and tactile capacitive measurement methods
- Different coating for different film types
- Adaptive reversing speed to ensure fast controlling
- No consequential costs caused by isotopes or X-rays
- Short control loop due to measurement on the bubble



thicknessCONTROL8104.CI  
(for abrasive film)



thicknessCONTROL8104.CII  
(for abrasive film)



thicknessCONTROL8104.CIII  
(Teflon coating)



thicknessCONTROL8104.C  
(electrode made of stainless steel/uncoated)



thicknessCONTROL8104.NC  
(non-contact)

#### thicknessCONTROL TCP 8101.CT/CLLT

Article no.	4350133.100	4350133.101	4350133.102	4350133.103	4350006.520	4350006.520	4350006.520	4350006.520
Measuring width	700 mm	1200 mm	1700 mm	2200 mm	700 mm	1200 mm	1700 mm	2200 mm
Measuring range	50 mm				75 mm <sup>3)</sup>			
Resolution	1 $\mu$ m							
Accuracy 1	$\pm 5 \mu$ m				$\pm 3 \mu$ m			
Repeatability <sup>1)</sup>	0.5 $\mu$ m				0.5 $\mu$ m			
Material temperature <sup>2)</sup>	60 °C							

<sup>1)</sup> 2  $\sigma$

<sup>2)</sup> Without additional cooling

<sup>3)</sup> Min. material thickness 15 mm

### Technologies



#### thicknessCONTROL STG 8101.CLLT

Sensor used: laser profile scanner

- Measuring range: 75 mm
- Accuracy:  $\pm 3 \mu$ m
- Measuring width: up to 4000 mm

High performance thickness measuring system for thick webs or sheets even for profile thickness measurement

Can be equipped with cooling and pneumatic protective equipment for the optical system for harsh ambient conditions

# Wear inspection of the inner diameter of extruder barrels

## idiamCONTROL



- Suitable for extruder barrels from 32 to 180 mm diameter
- Factory calibration enables measurement on any metal
- Touchscreen for fast on-site evaluation
- Reduced service time
- Targeted inspection for replacement of defective segments

### Precise determination of the inner diameter of pipes

The idiamCONTROL sensor system precisely measures the inner diameter of bore holes such as in extruders in order to determine the wear. As the sensor measures a total of 6 tracks, the readings provide more accurate and meaningful measurement results.

For reliable guidance, the sensor system is centered at both ends by spring-loaded rollers. By rotating each cross roller through 40 degrees, the barrel bore can be measured in 6 tracks. The measurement itself is contactless.

### On-site evaluation via touchscreen

The measurement results are displayed on a compact touchscreen. The measurement signal represents the diameter over the complete bore length and any tolerance deviations are immediately displayed.

For data output the device is equipped with a USB port. A calibration control system checks the functionality of the measuring system.

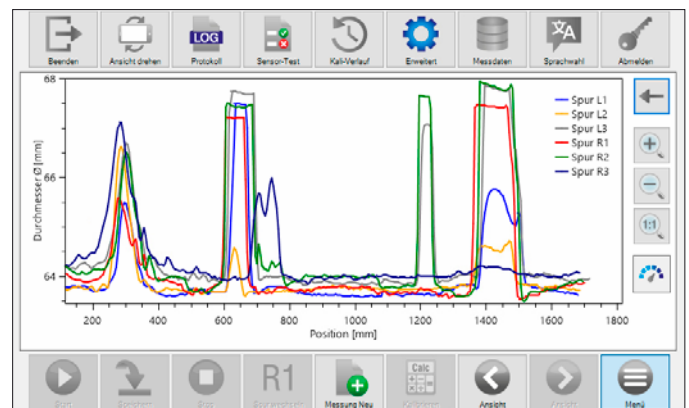

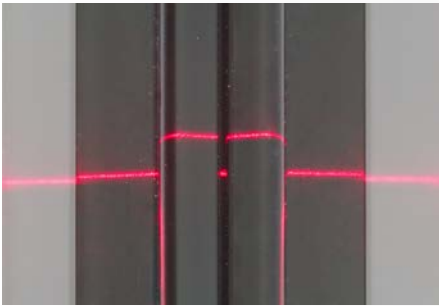

Gap measurement of plastic profiles

### Applications with sensor technology from Micro-Epsilon

Gap measurement of plastic profiles using scanCONTROL 3000

#### Advantages:

- High speed measurements
- 100% quality control
- Closed Loop control possible



Model	IDC803E / IDC801-SUxx	
Measuring range	8 / 18 mm	
Accuracy	±0.02 mm	
Resolution	16 bits (1 µm)	
Spatial resolution (longitudinal position)	1 mm (max. speed: 100 mm/s)	
Interface	USB	
Temperature	+5 ... +60 °C	
Humidity	5 - 95% (non-condensing)	
Protection class	Sensor	IP40
	Controller	IP40
	Power supply	IP20

### Functional principle

The measuring system uses two capacitive displacement sensors arranged opposite each other to determine the diameter of the barrel bore. For the measurement, the sensor is pushed to the end of the extruder barrel and pulled out while measuring the bore hole. The reinforced cable is attached to the sensor with a special plug. The diameter values of several test cycles can be saved. The results of the measured tracks are then offset against each other to determine the wear.

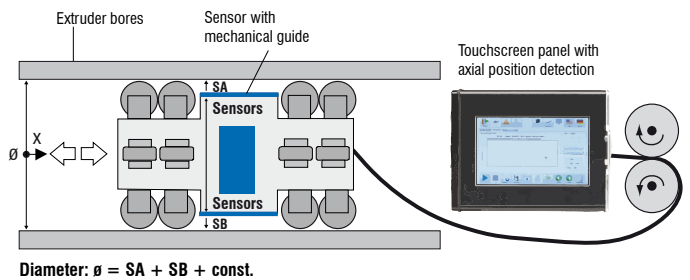

## Your local support

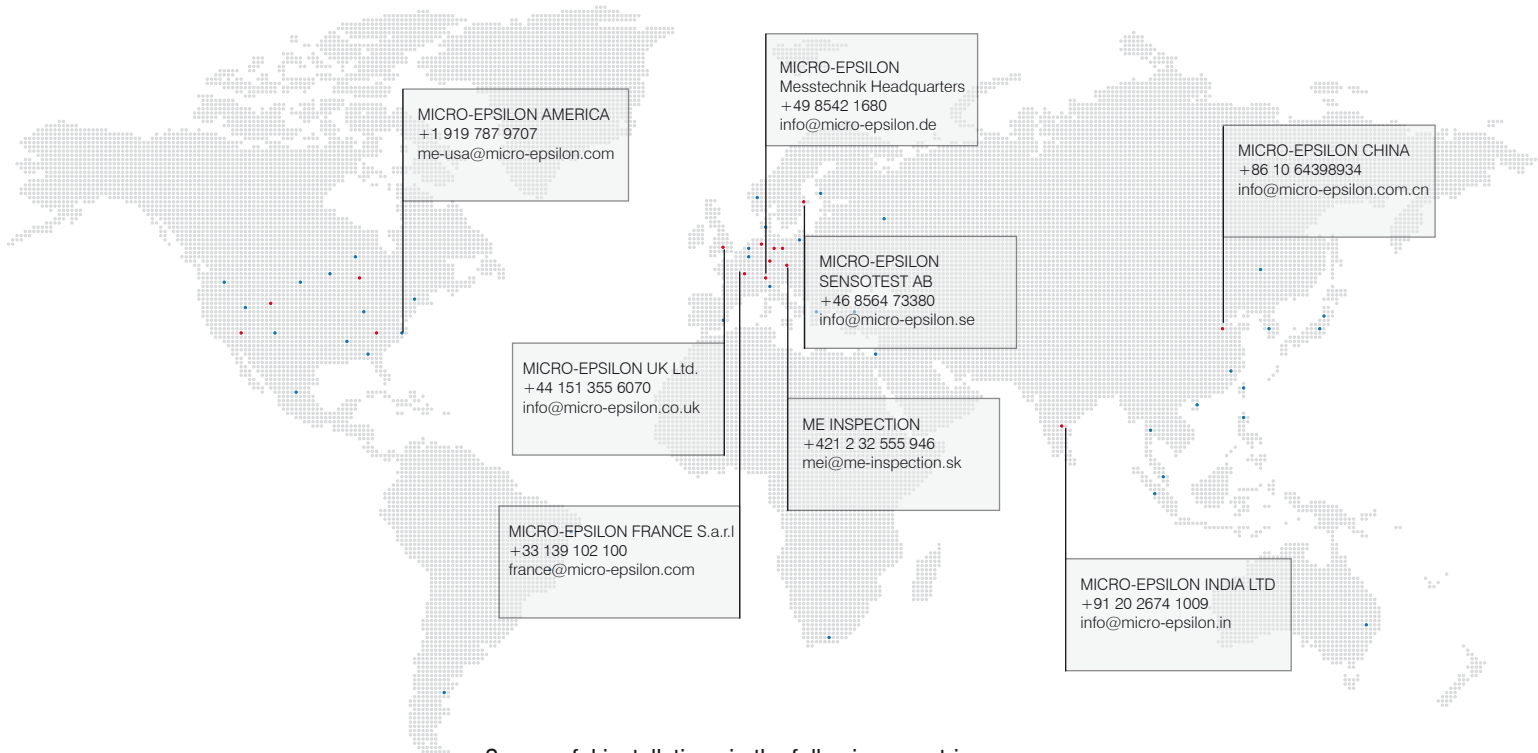

## Successful installations in the following countries



**MICRO-EPSILON**

### More precision for added value

Performance and quality, as well as reliability of products and services have made Micro-Epsilon Messtechnik GmbH & Co. KG one of the leading suppliers of inspection systems for optical thickness measurement used in the metal industry. Numerous, successful installations in 13 countries around the world in milling lines and processing lines speak for themselves. Developing and producing all the necessary core components such as sensors, software and measurement-specific machine building inside the company group provides unique innovative skills that are mirrored in the product portfolio of Micro-Epsilon.

MICRO-EPSILON Headquarters  
Koenigbacher Str. 15 · 94496 Ortenburg / Germany  
Tel. +49 (0) 8542 / 168-0 · Fax +49 (0) 8542 / 168-90  
info@micro-epsilon.com · www.micro-epsilon.com